

HORIZONTAL CURVE DATA

CURVE NO.	RADIUS	DELTA	LENGTH	CHORD	TANGENT
1	312' 0"	17° 29'	64.02'	61.89'	34.13'
2	234' 0"	17° 12'	74.23'	71.95'	24.12'
3	238' 0"	17° 01'	75.17'	72.82'	24.18'
4	150' 0"	17° 00'	117.48'	114.27'	23.11'
5	150' 0"	17° 00'	117.48'	114.27'	23.11'
6	150' 0"	17° 00'	117.48'	114.27'	23.11'
7	150' 0"	17° 00'	117.48'	114.27'	23.11'
8	80' 0"	63° 35'	38.80'	38.31'	9.42'
9	238' 0"	17° 00'	75.17'	72.82'	24.18'
10	238' 0"	17° 00'	75.17'	72.82'	24.18'
11	30' 0"	12° 32'	42.45'	42.45'	30.00'
12	30' 0"	12° 32'	42.45'	42.45'	30.00'
13	30' 0"	12° 32'	42.45'	42.45'	30.00'
14	766' 0"	4° 48'	64.23'	64.21'	32.13'
15	30' 0"	8° 00'	43.33'	43.33'	28.33'
16	750' 0"	4° 02'	105.31'	105.22'	52.78'
17	750' 0"	4° 02'	105.31'	105.22'	52.78'
18	750' 0"	4° 02'	105.31'	105.22'	52.78'
19	750' 0"	4° 02'	105.31'	105.22'	52.78'
20	750' 0"	4° 02'	105.31'	105.22'	52.78'
21	750' 0"	4° 02'	105.31'	105.22'	52.78'
22	750' 0"	4° 02'	105.31'	105.22'	52.78'
23	30' 0"	78° 39'	41.39'	41.39'	32.84'
24	30' 0"	78° 39'	41.39'	41.39'	32.84'
25	766' 0"	5° 16'	45.70'	45.39'	35.31'
26	30' 0"	90° 00'	47.12'	42.43'	30.00'
27	10' 0"	90° 00'	15.71'	14.14'	10.00'
28	20' 0"	160° 00'	55.93'	63.41'	115.03'
29	30' 0"	90° 00'	47.12'	42.43'	30.00'
30	30' 0"	90° 00'	47.12'	42.43'	30.00'
31	30' 0"	90° 00'	47.12'	42.43'	30.00'
32	30' 0"	90° 00'	47.12'	42.43'	30.00'
33	30' 0"	90° 00'	47.12'	42.43'	30.00'
34	30' 0"	90° 00'	47.12'	42.43'	30.00'
35	30' 0"	90° 00'	47.12'	42.43'	30.00'
36	30' 0"	90° 00'	47.12'	42.43'	30.00'
37	173' 0"	46° 21'	66.66'	66.66'	103.28'
38	173' 0"	46° 21'	66.66'	66.66'	103.28'
39	173' 0"	46° 21'	66.66'	66.66'	103.28'
40	173' 0"	46° 21'	66.66'	66.66'	103.28'
41	173' 0"	46° 21'	66.66'	66.66'	103.28'
42	173' 0"	46° 21'	66.66'	66.66'	103.28'
43	42' 0"	45° 00'	32.59'	32.13'	17.40'

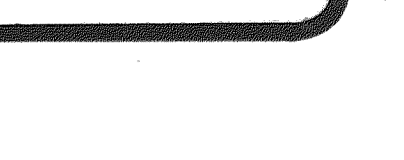
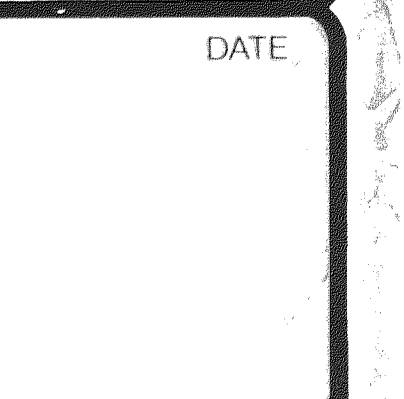
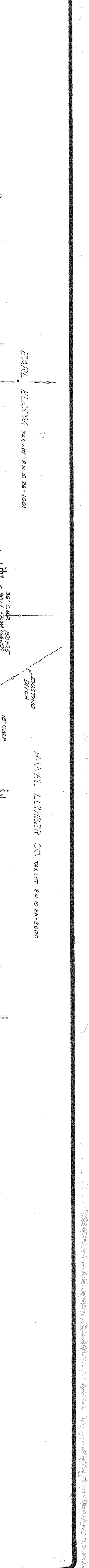
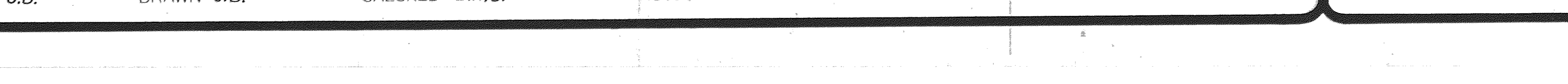
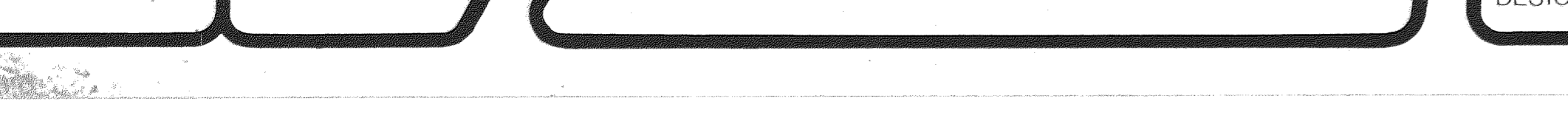
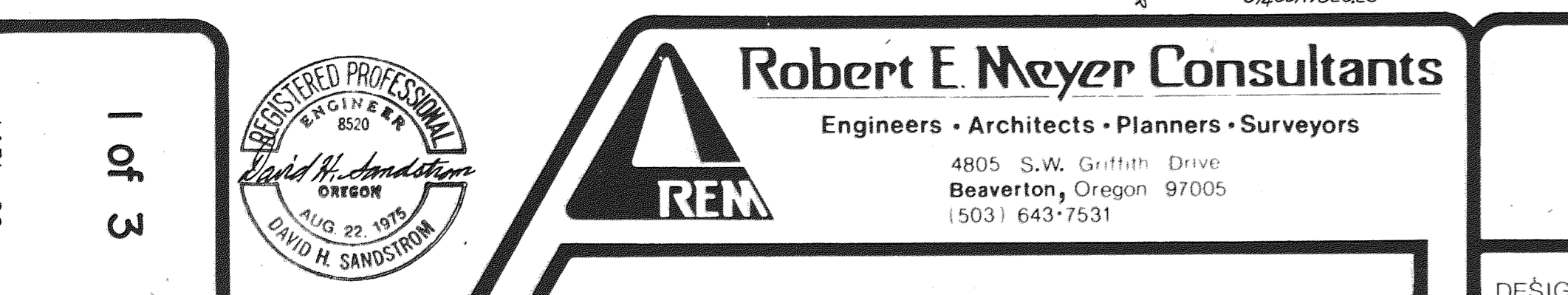
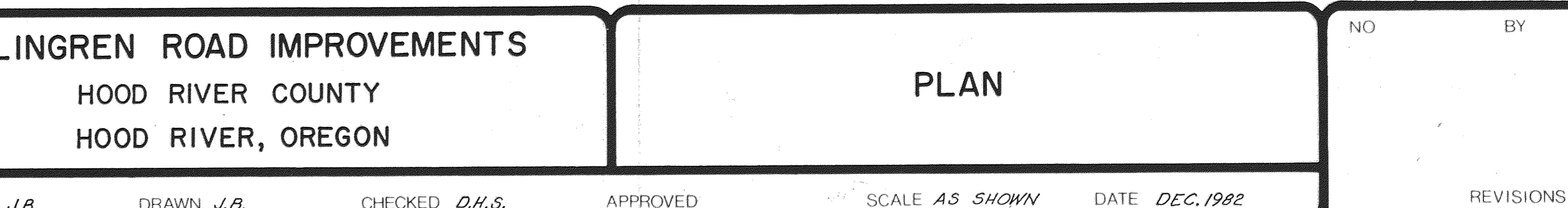
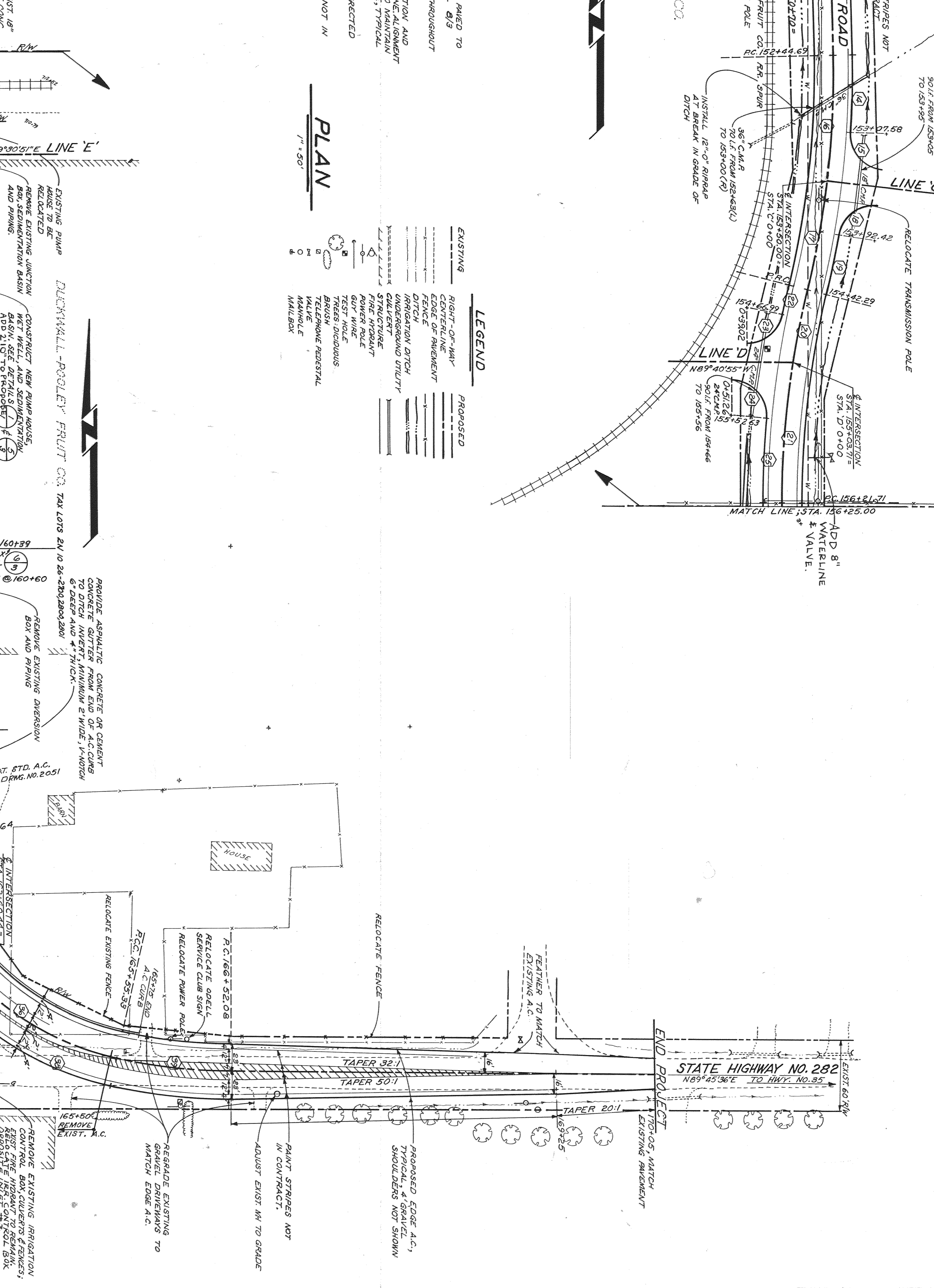
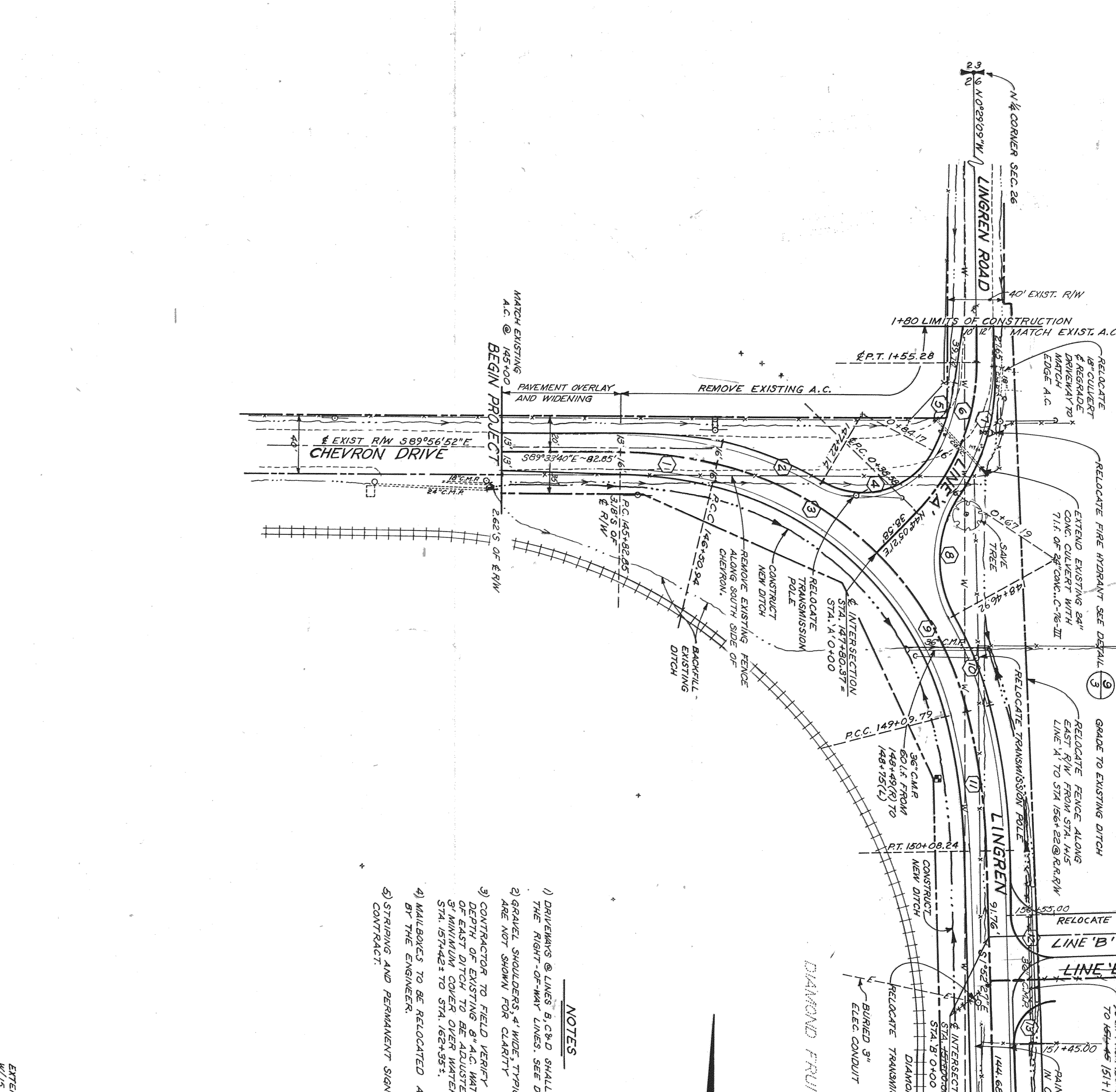
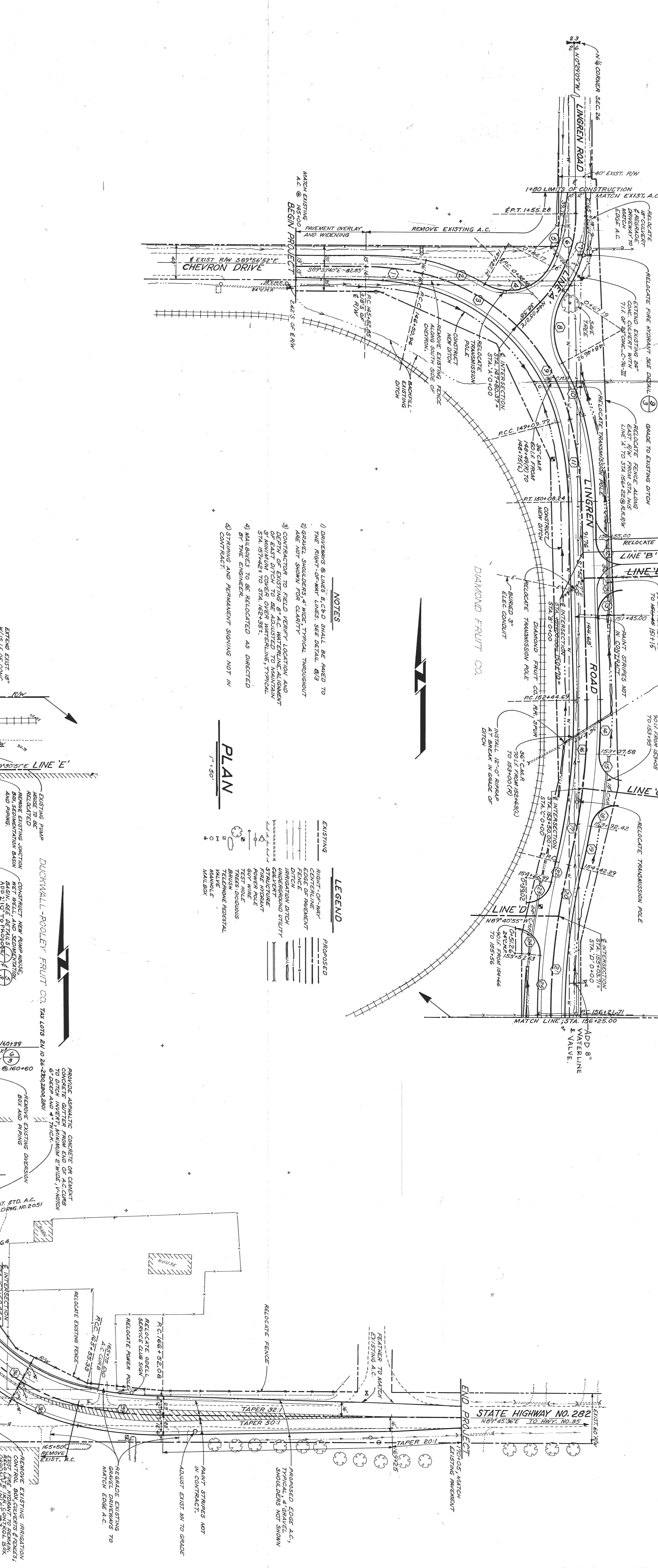
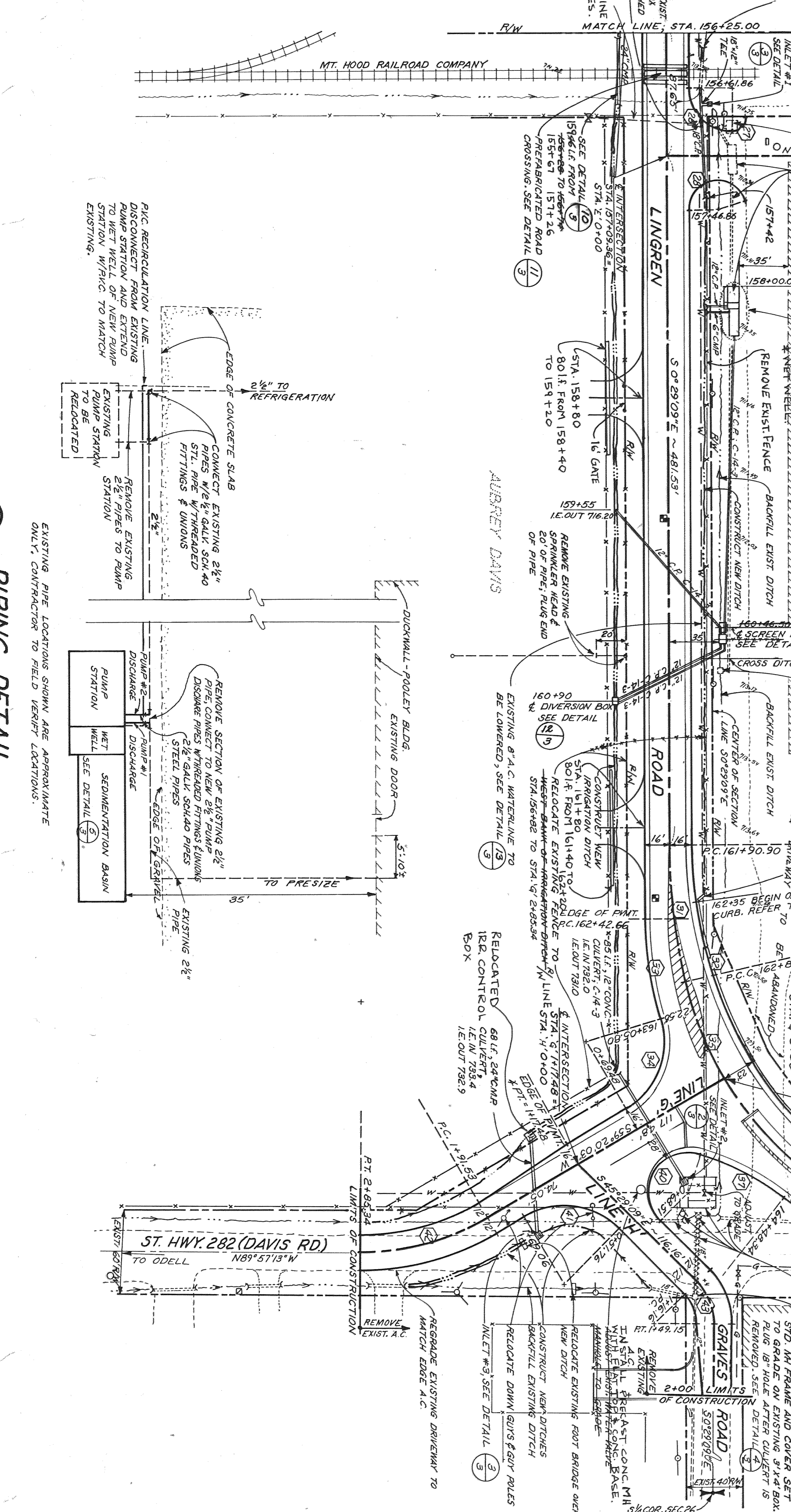

1 of 3
1451-00
7187

Robert E. Meyer Consultants
Engineers • Architects • Planners • Surveyors
4805 S.W. Griffin Drive
Beaverton, Oregon 97005
5031 643-7531

LINGREN ROAD IMPROVEMENTS
HOOD RIVER COUNTY
HOOD RIVER, OREGON

DESIGN J.B. DRAWN J.B. CHECKED D.H.S. APPROVED
SCALE AS SHOWN DATE DEC. 1982

NO. BY DATE
REVISIONS

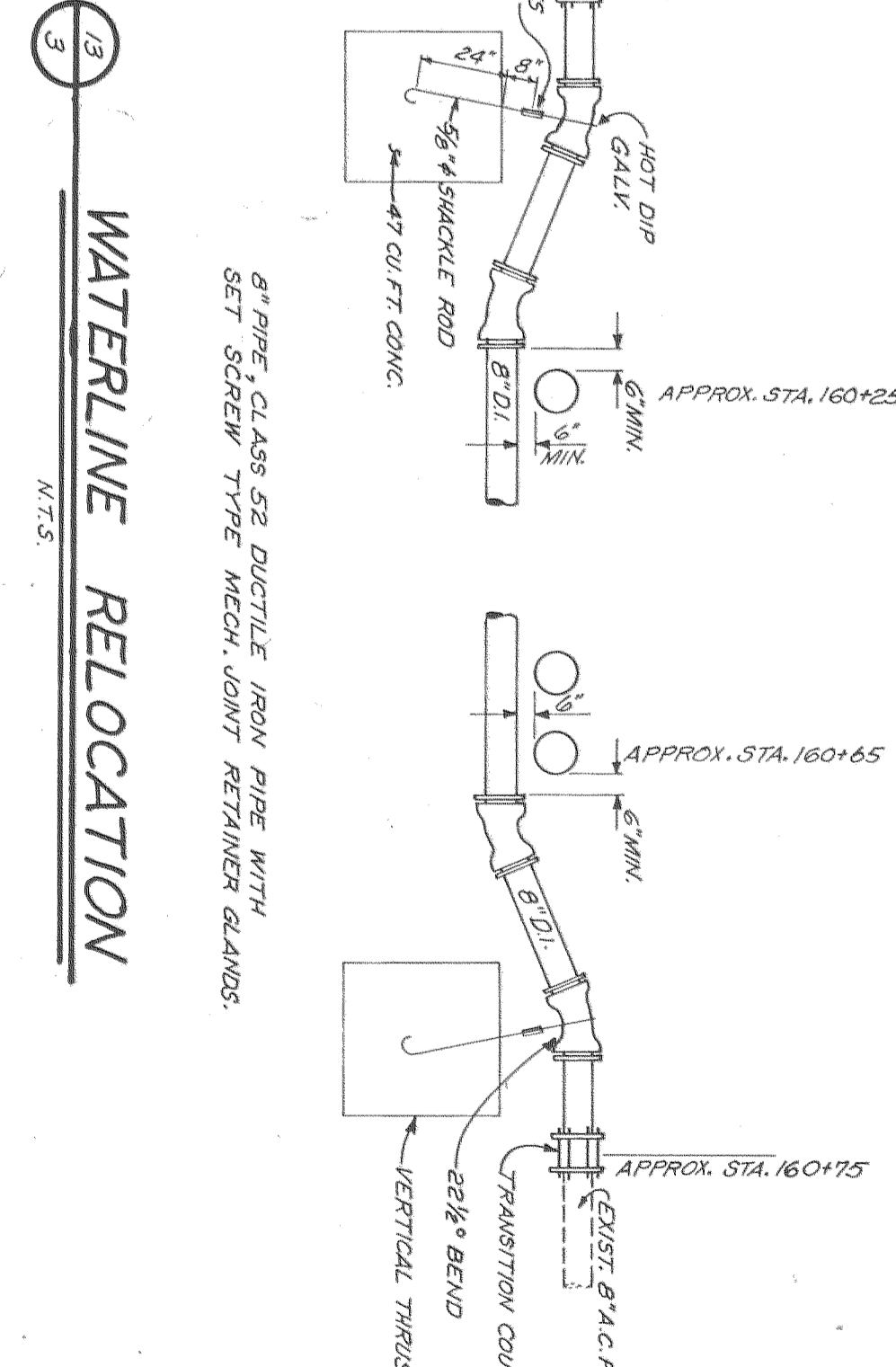
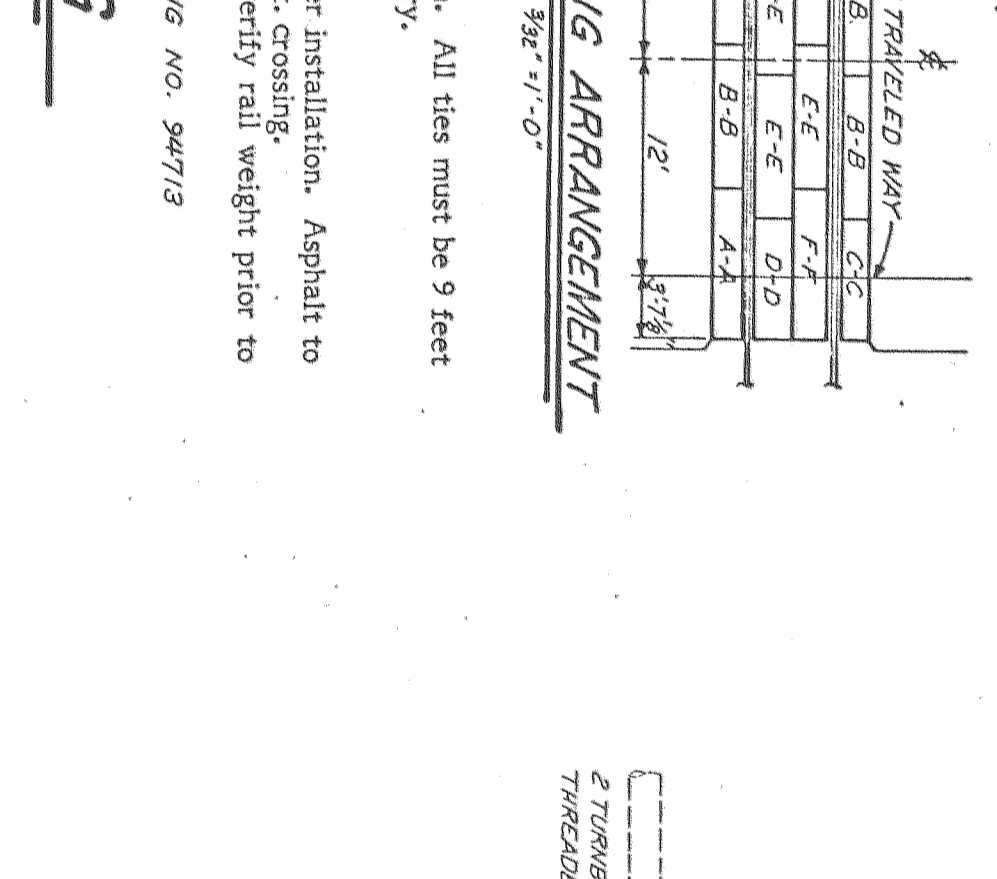
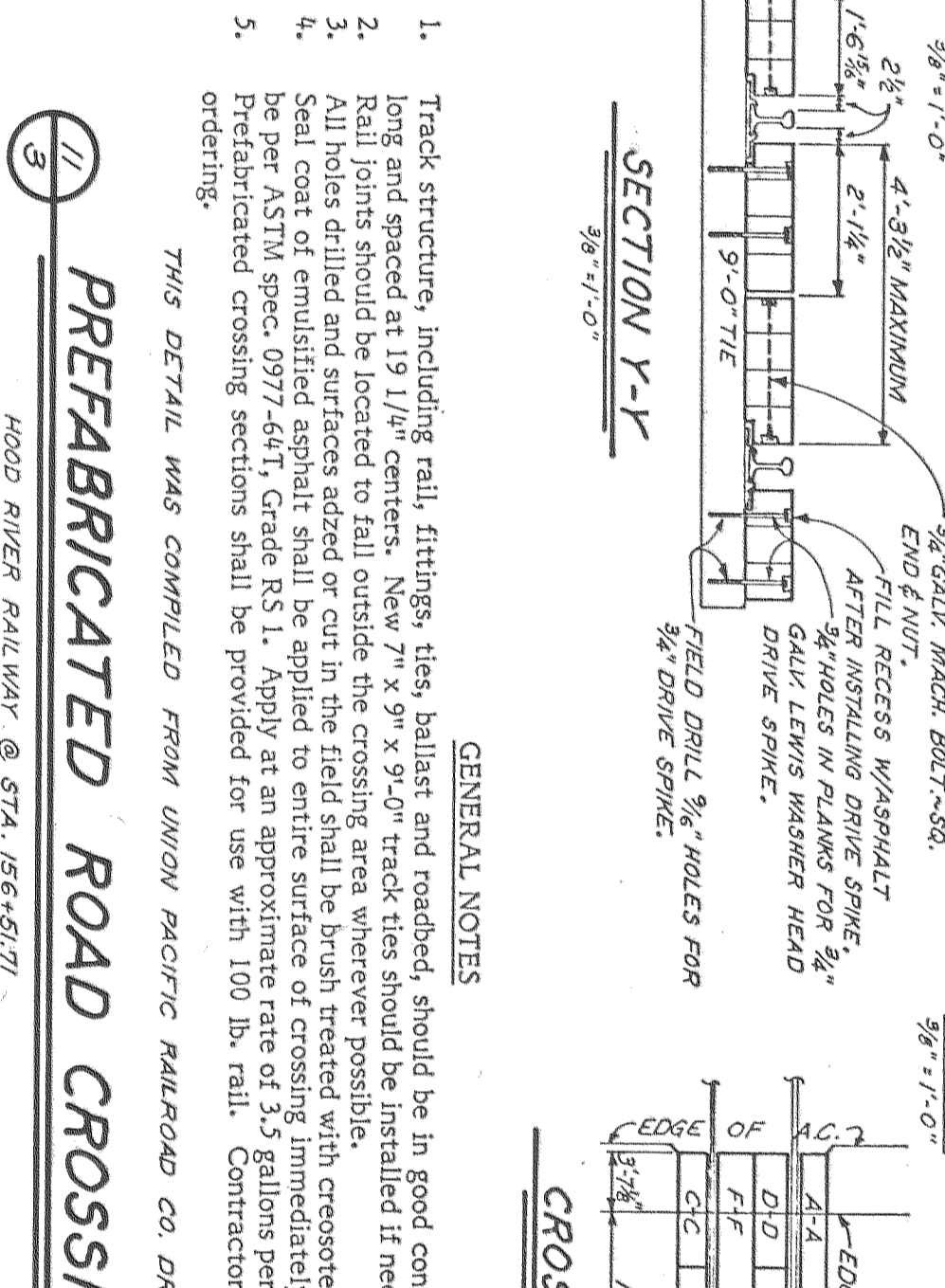
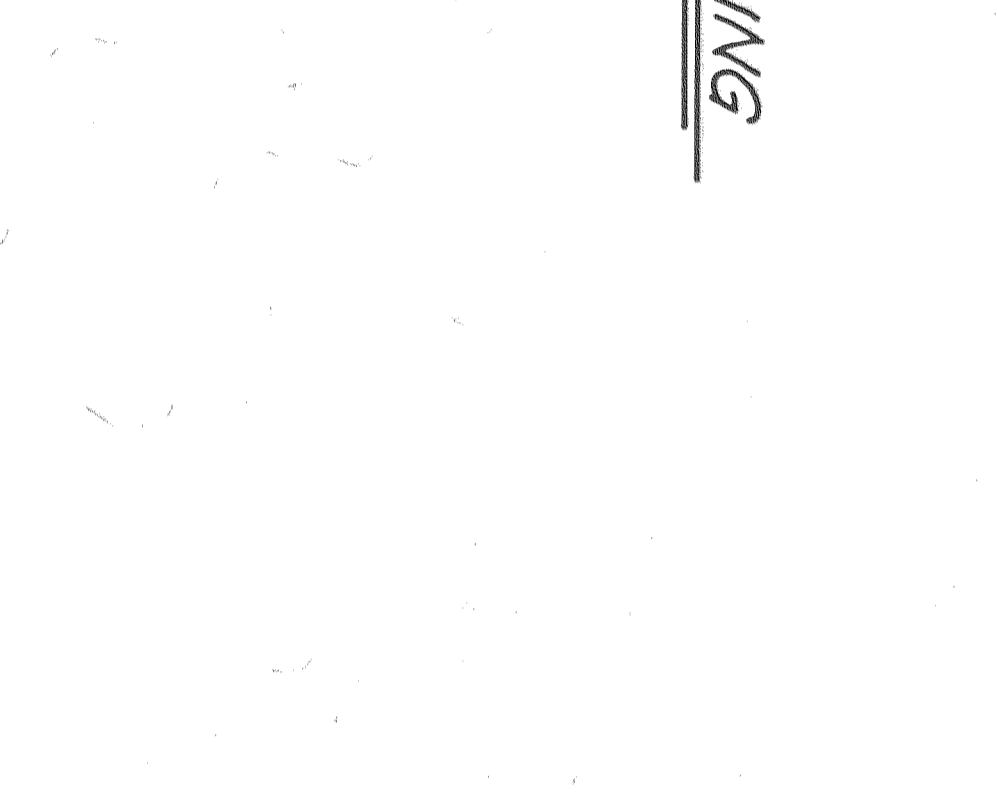
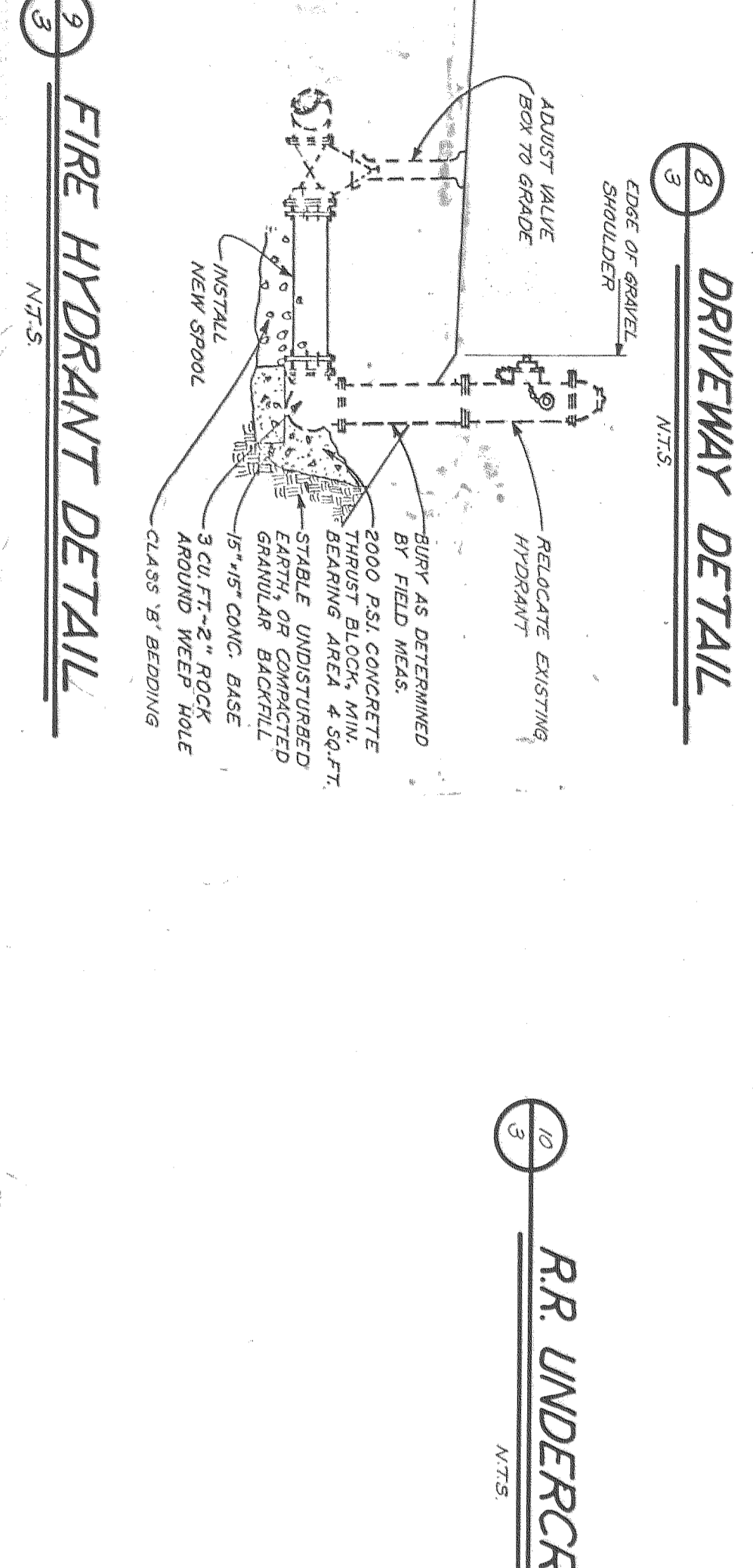
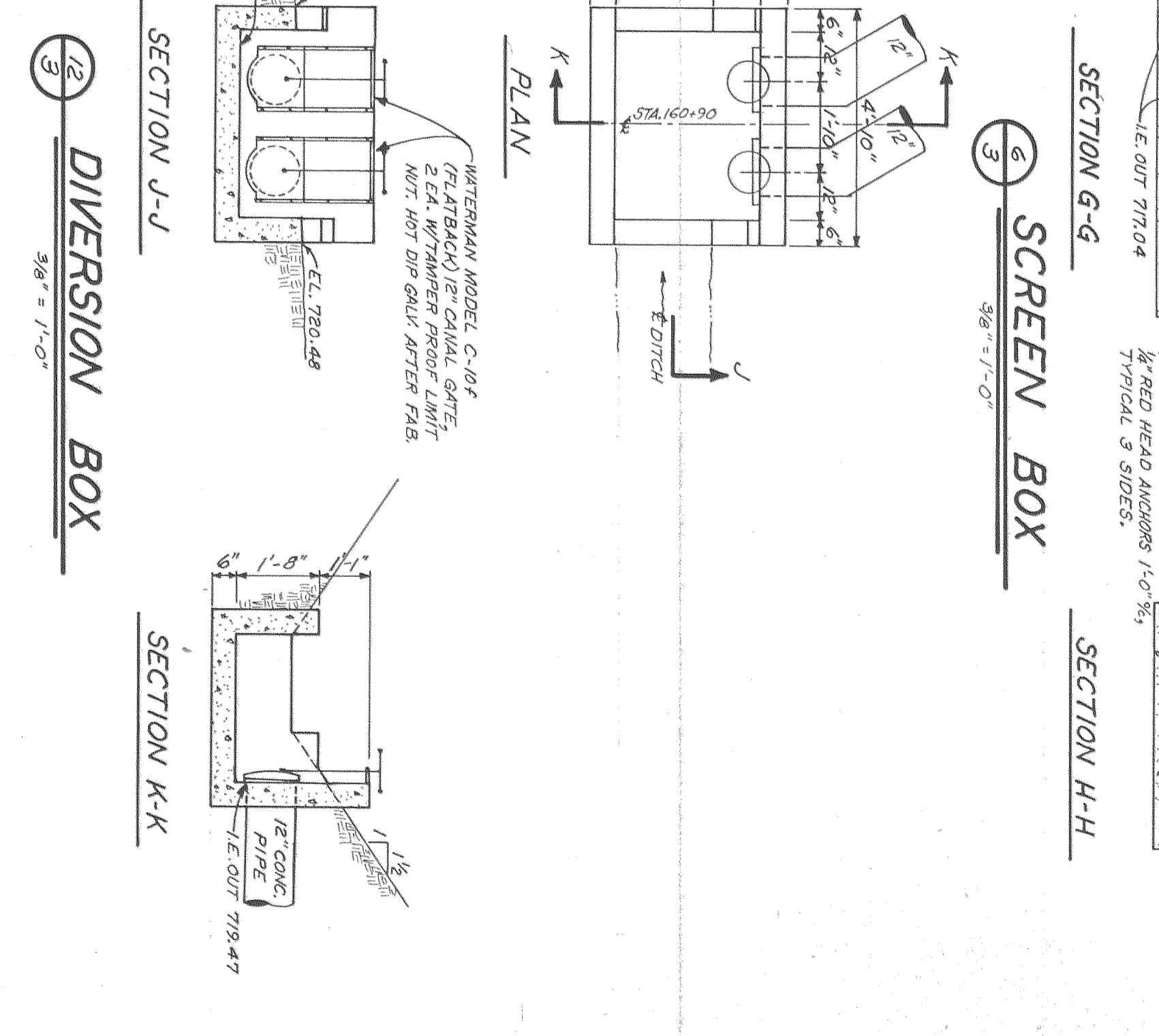
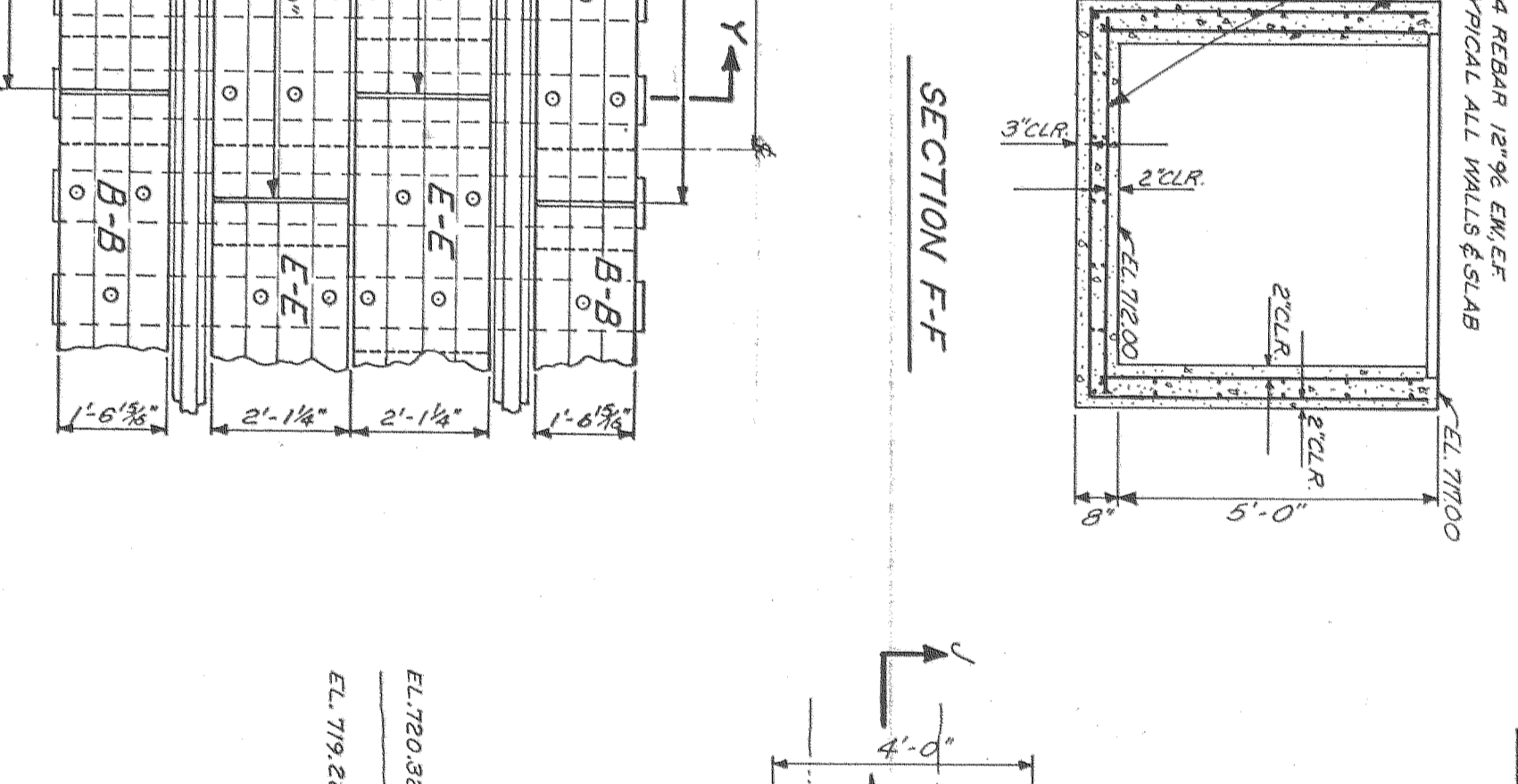
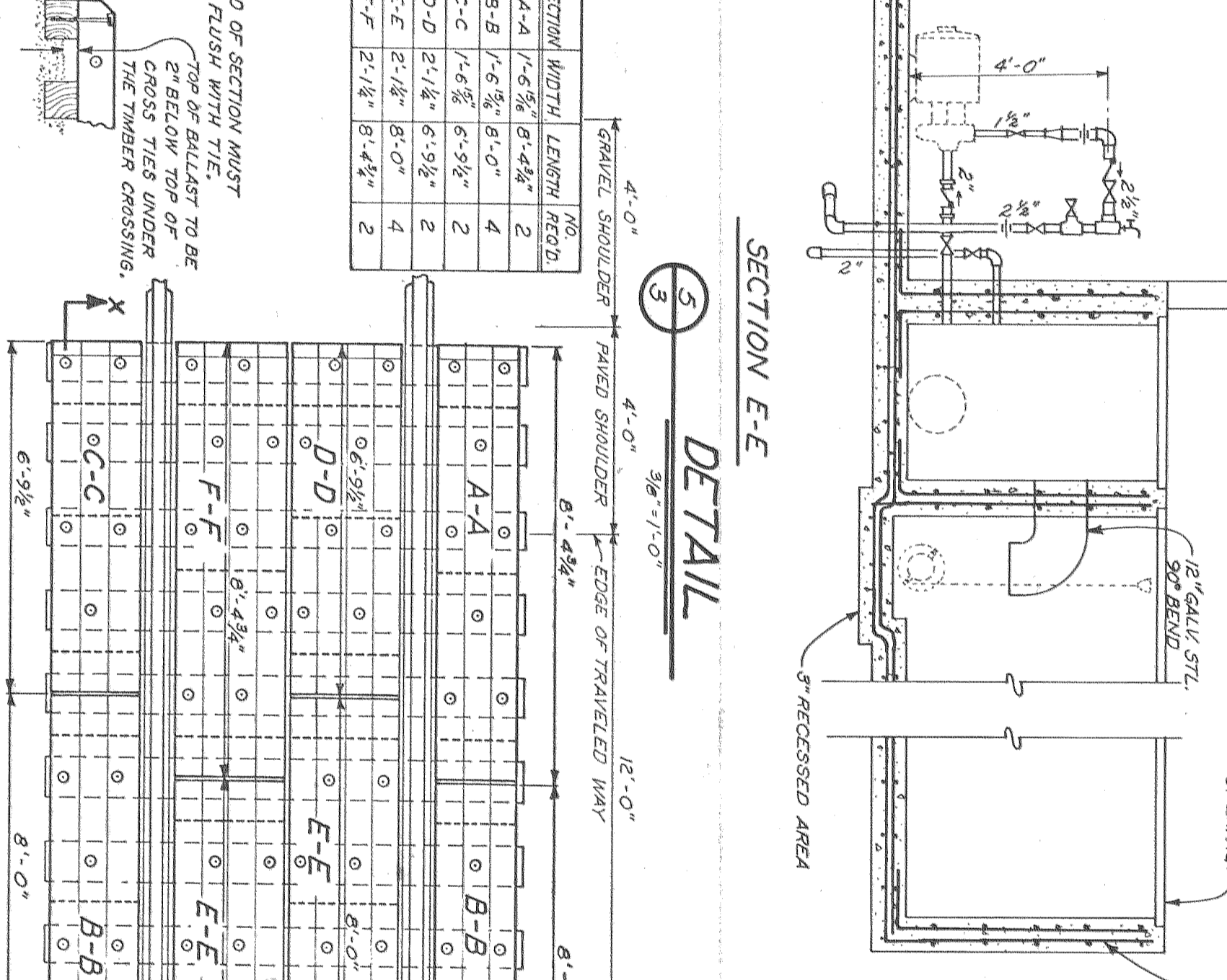
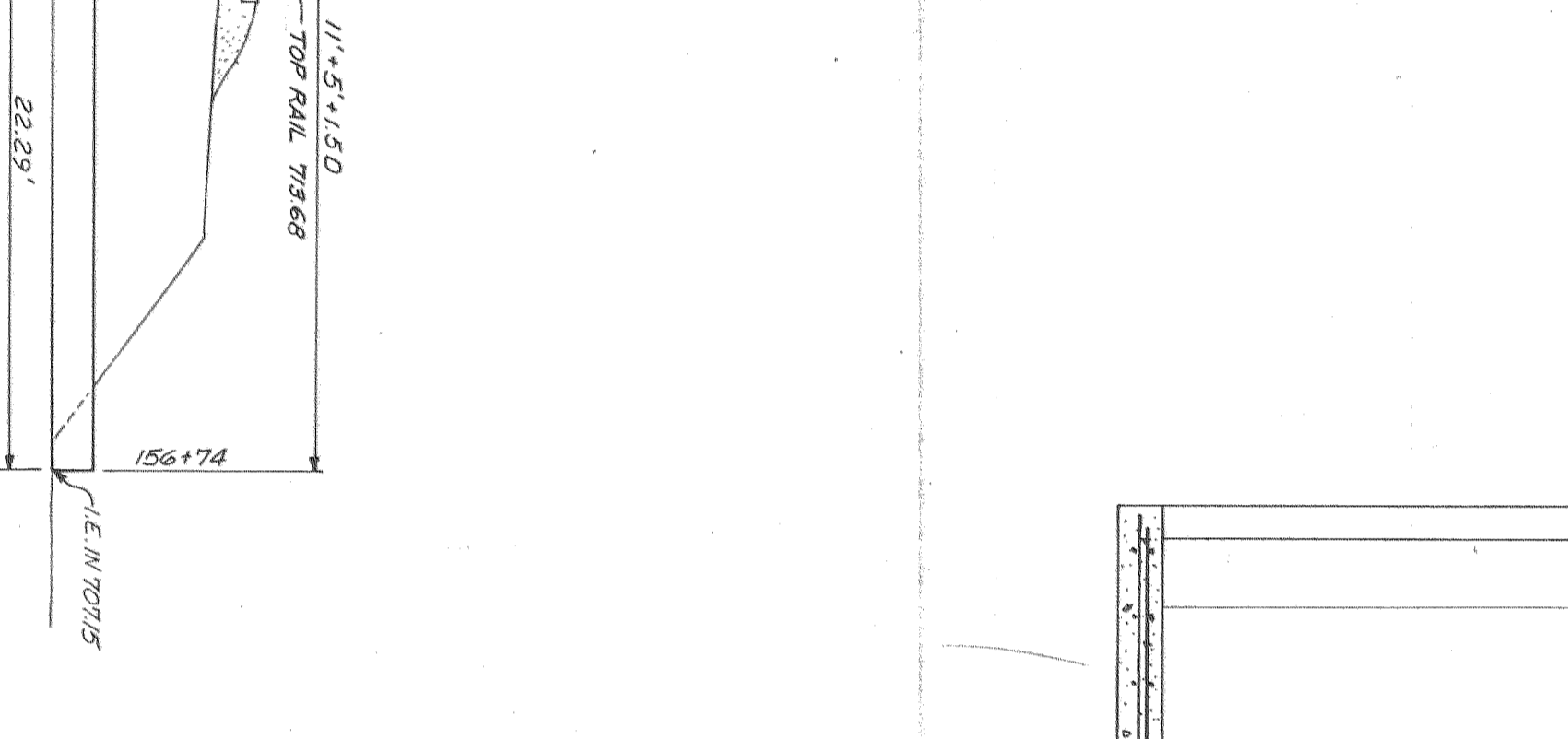
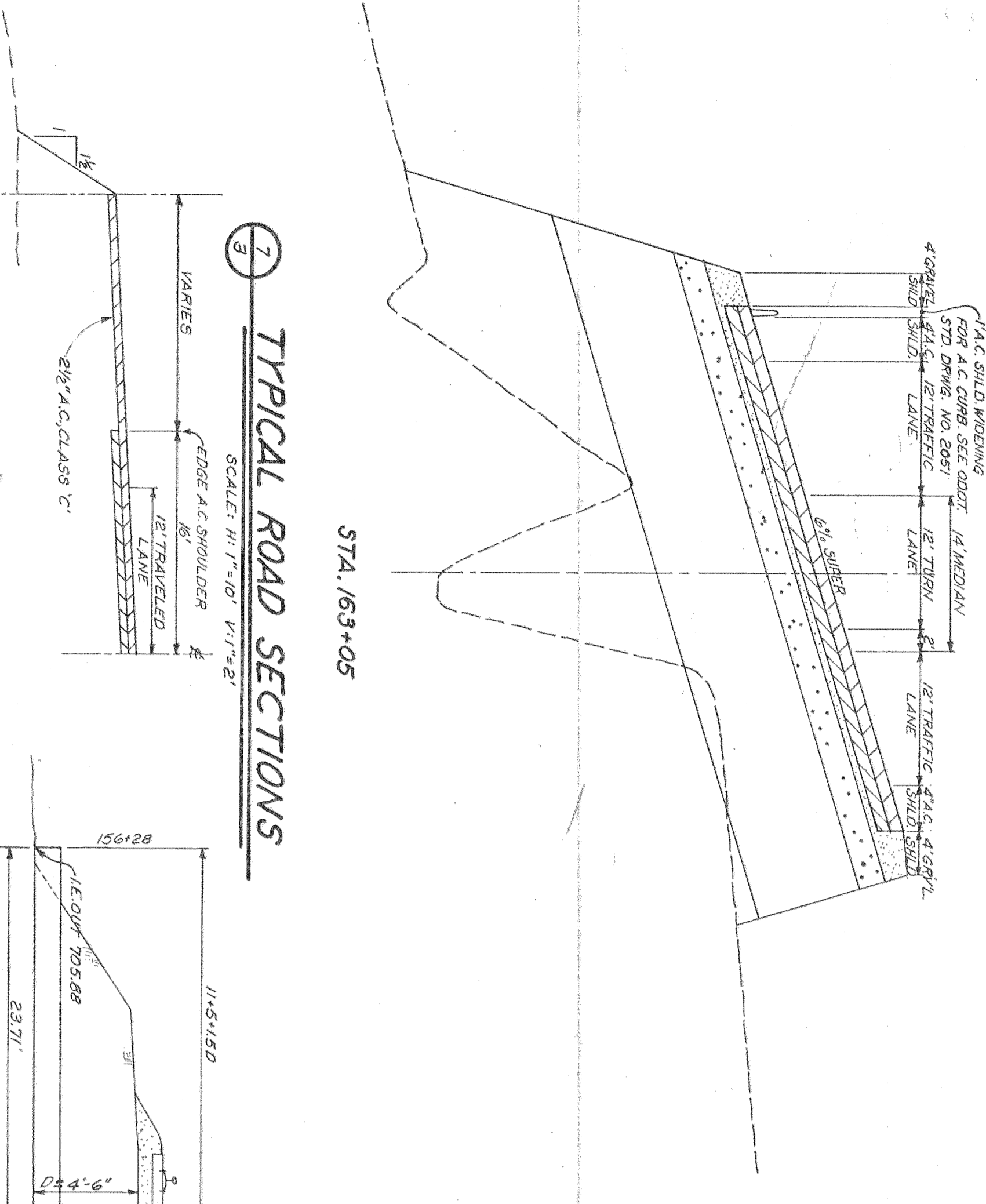
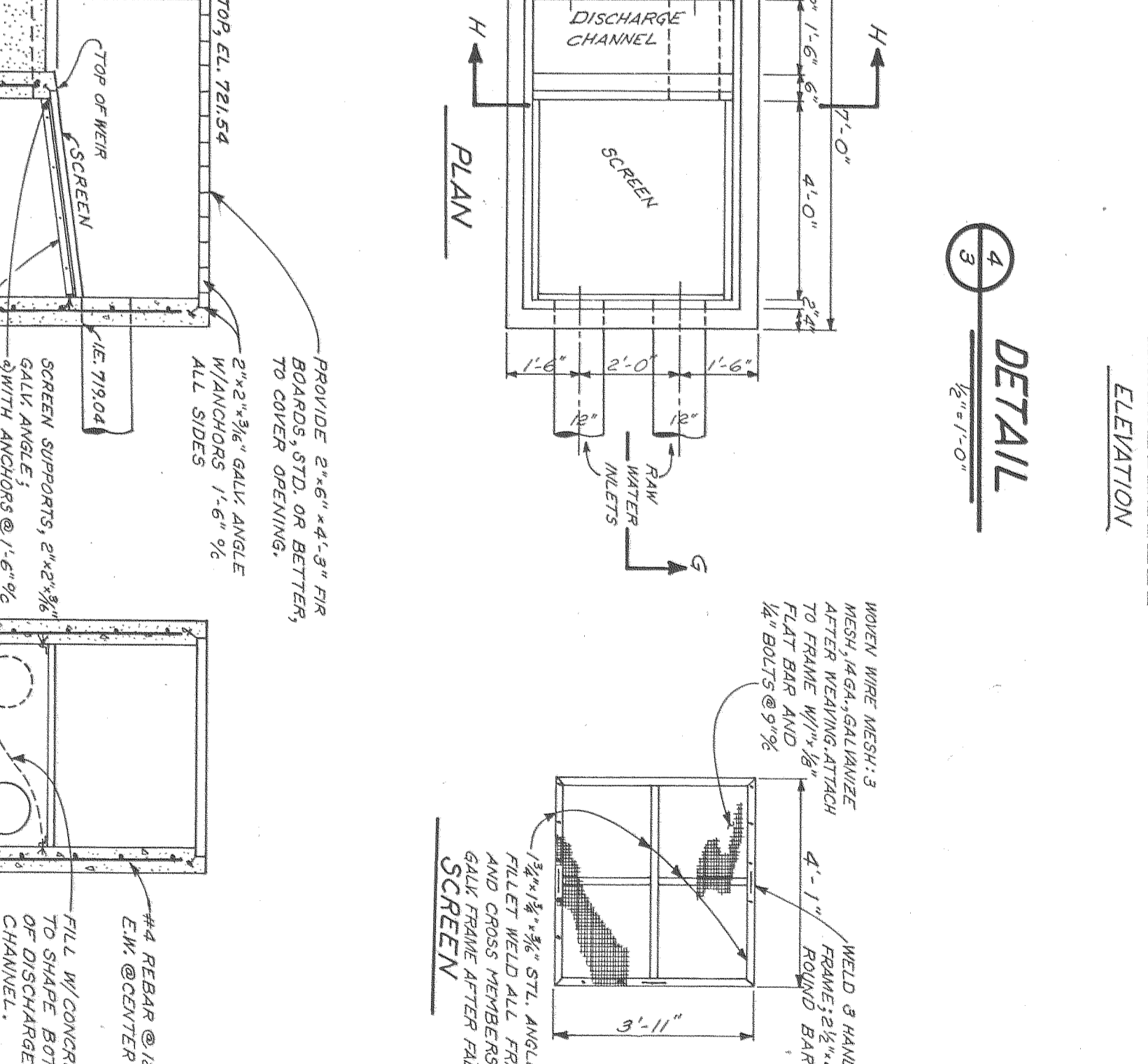
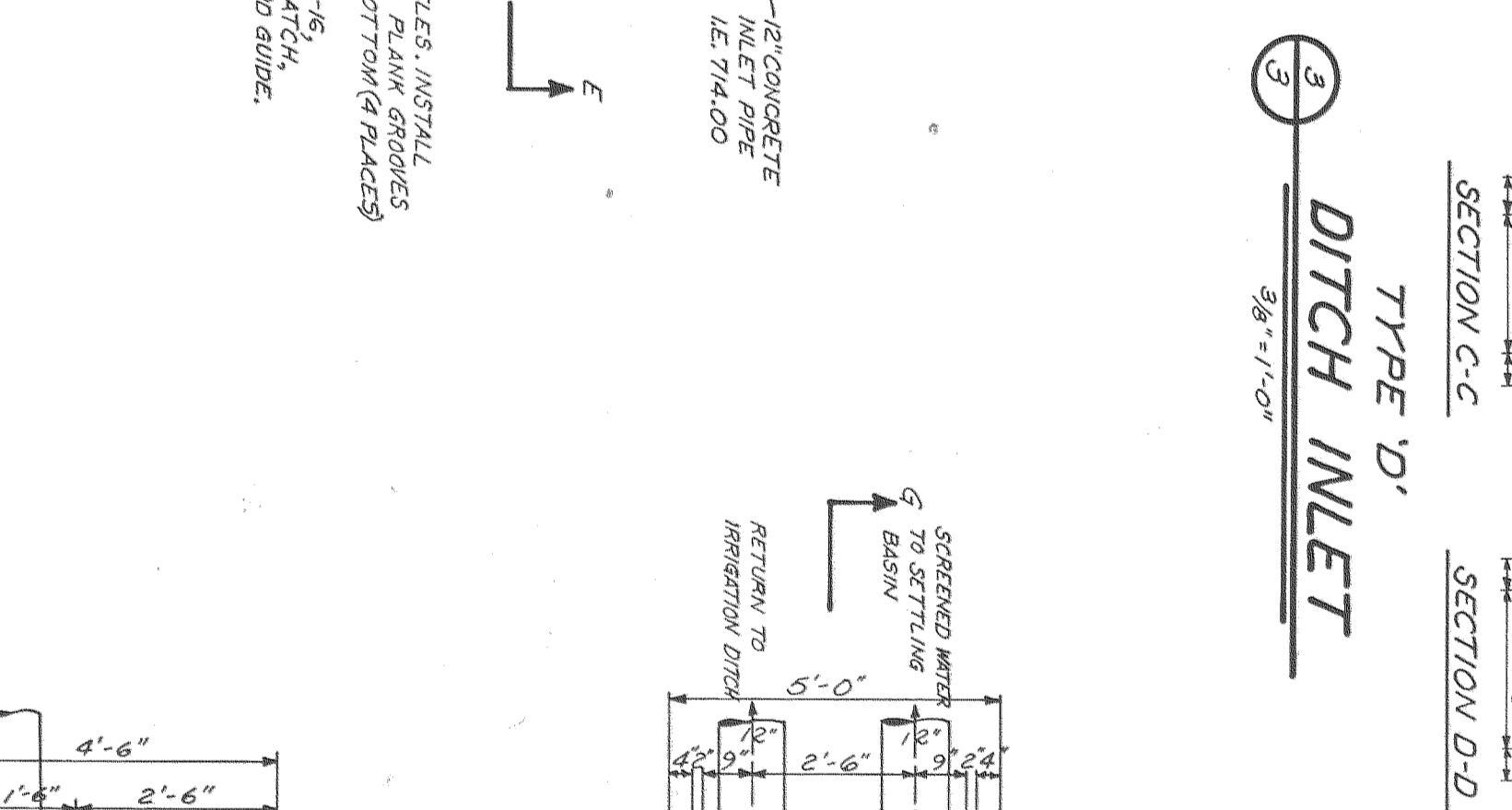
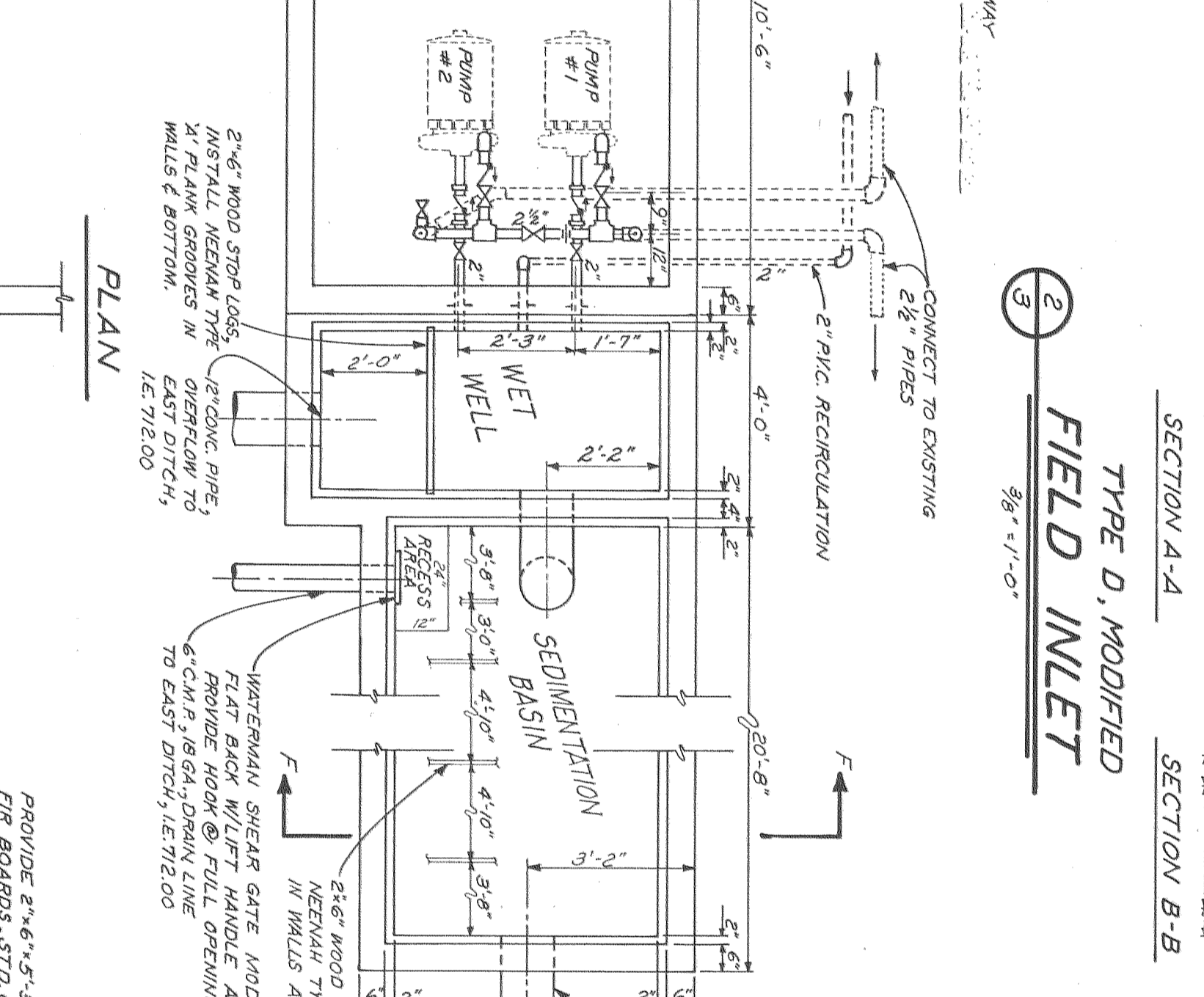
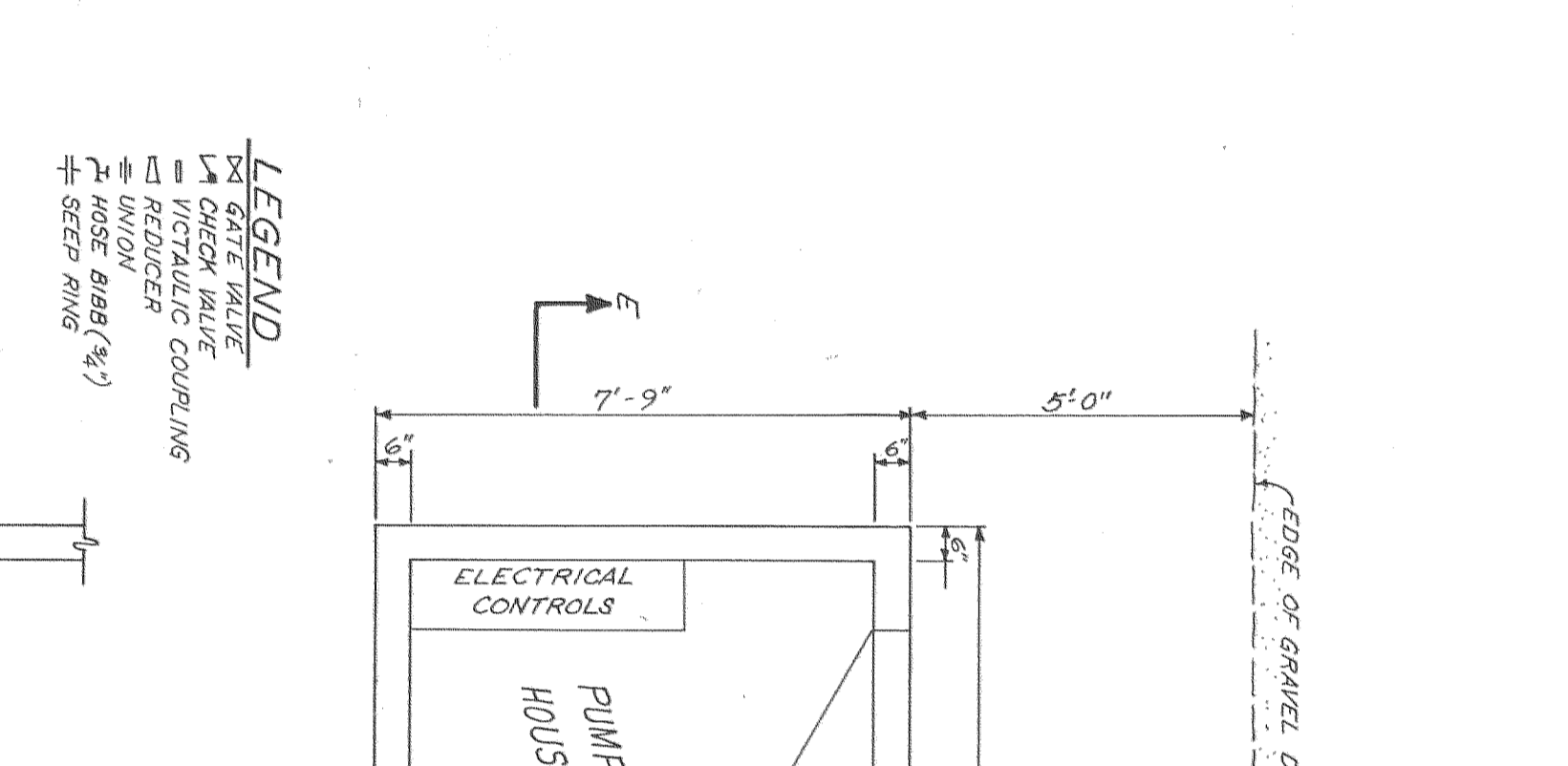
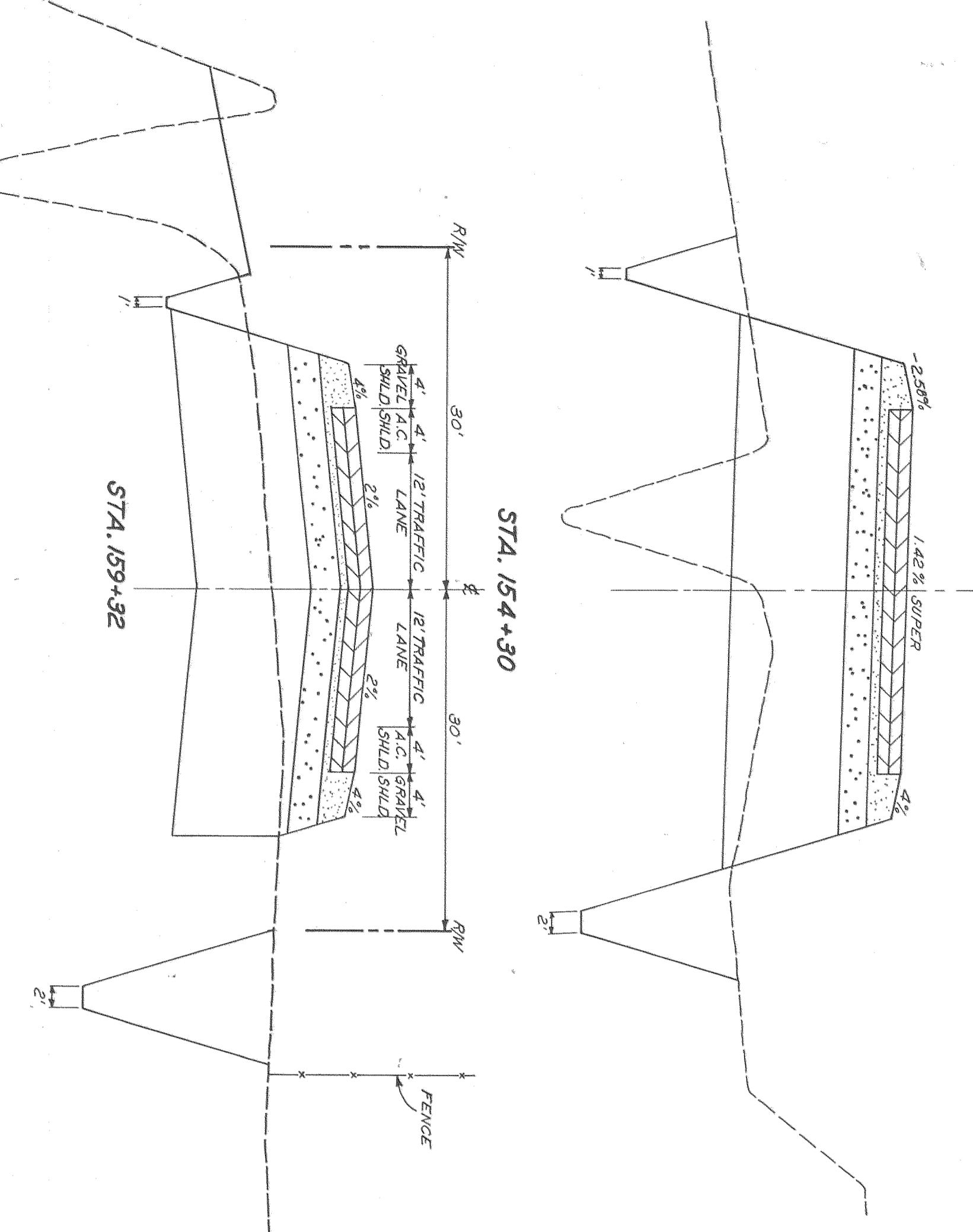
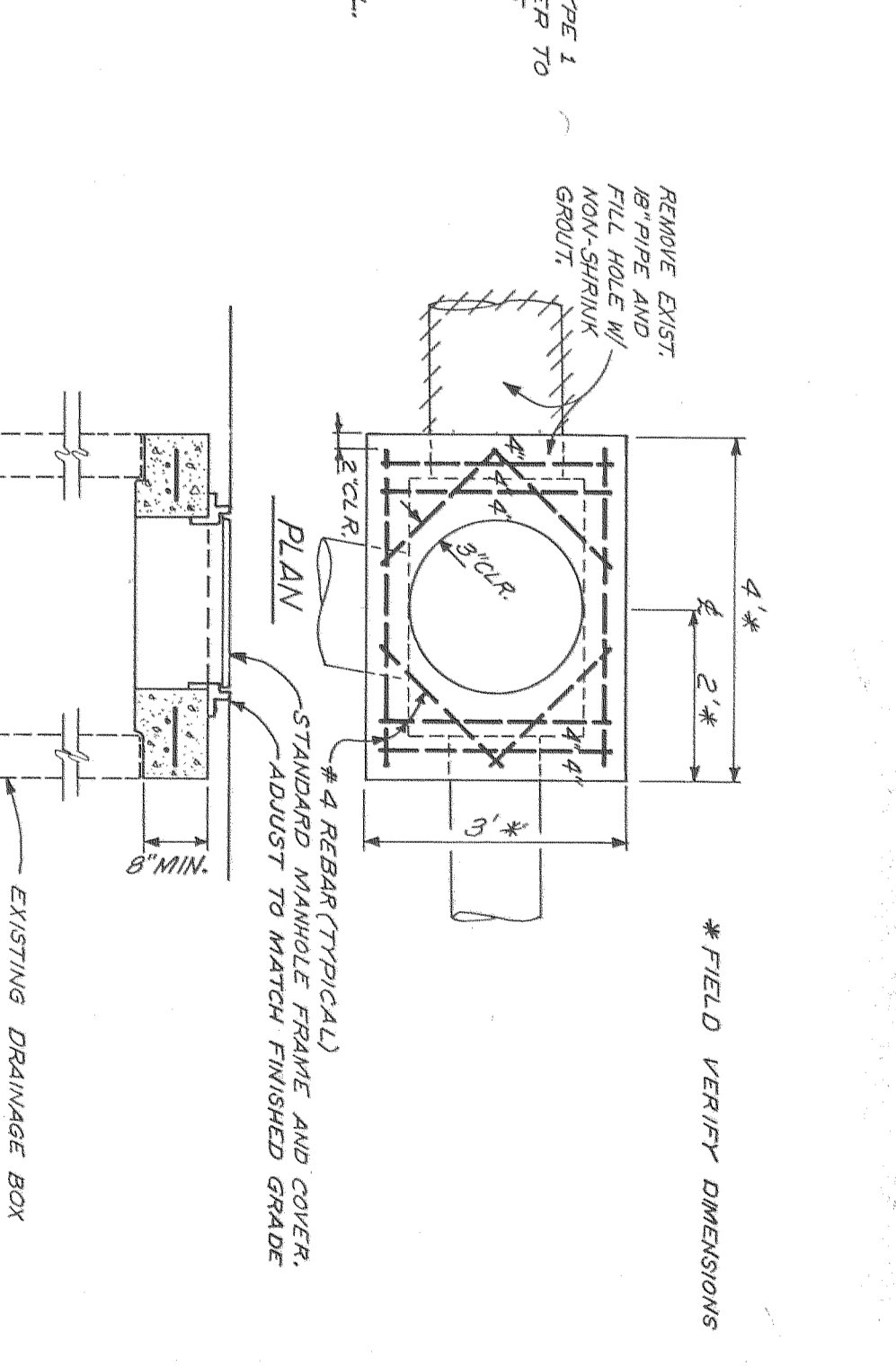
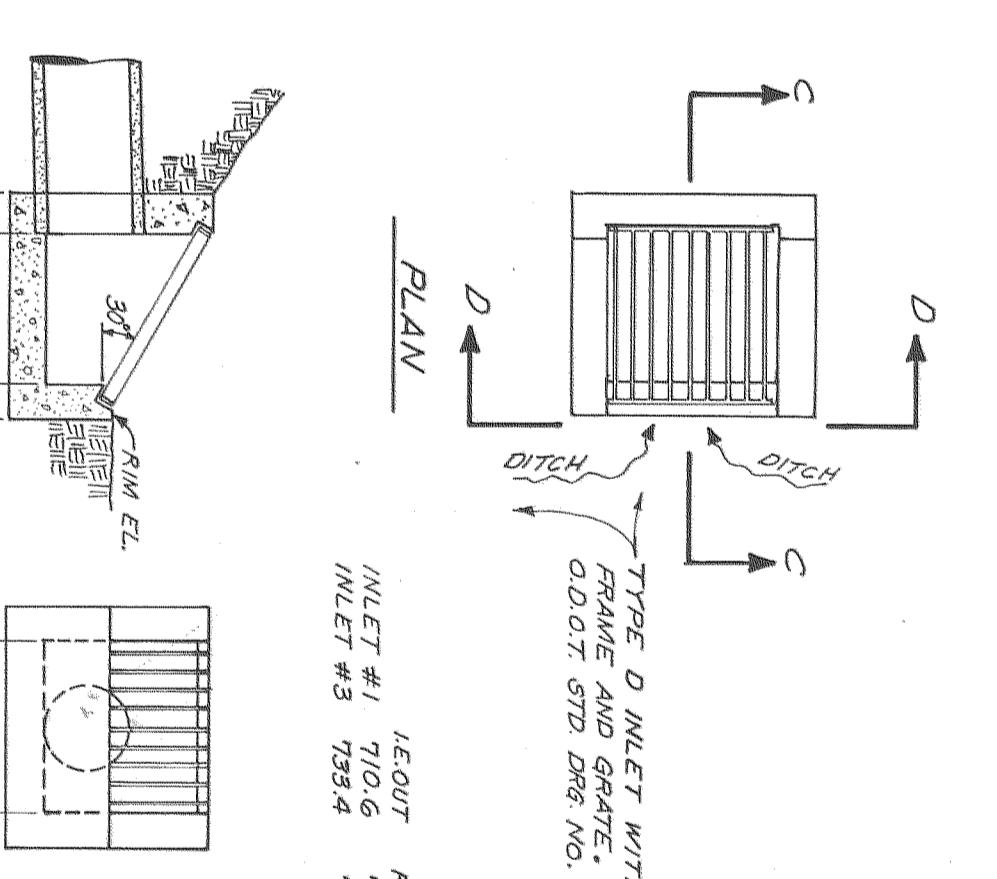
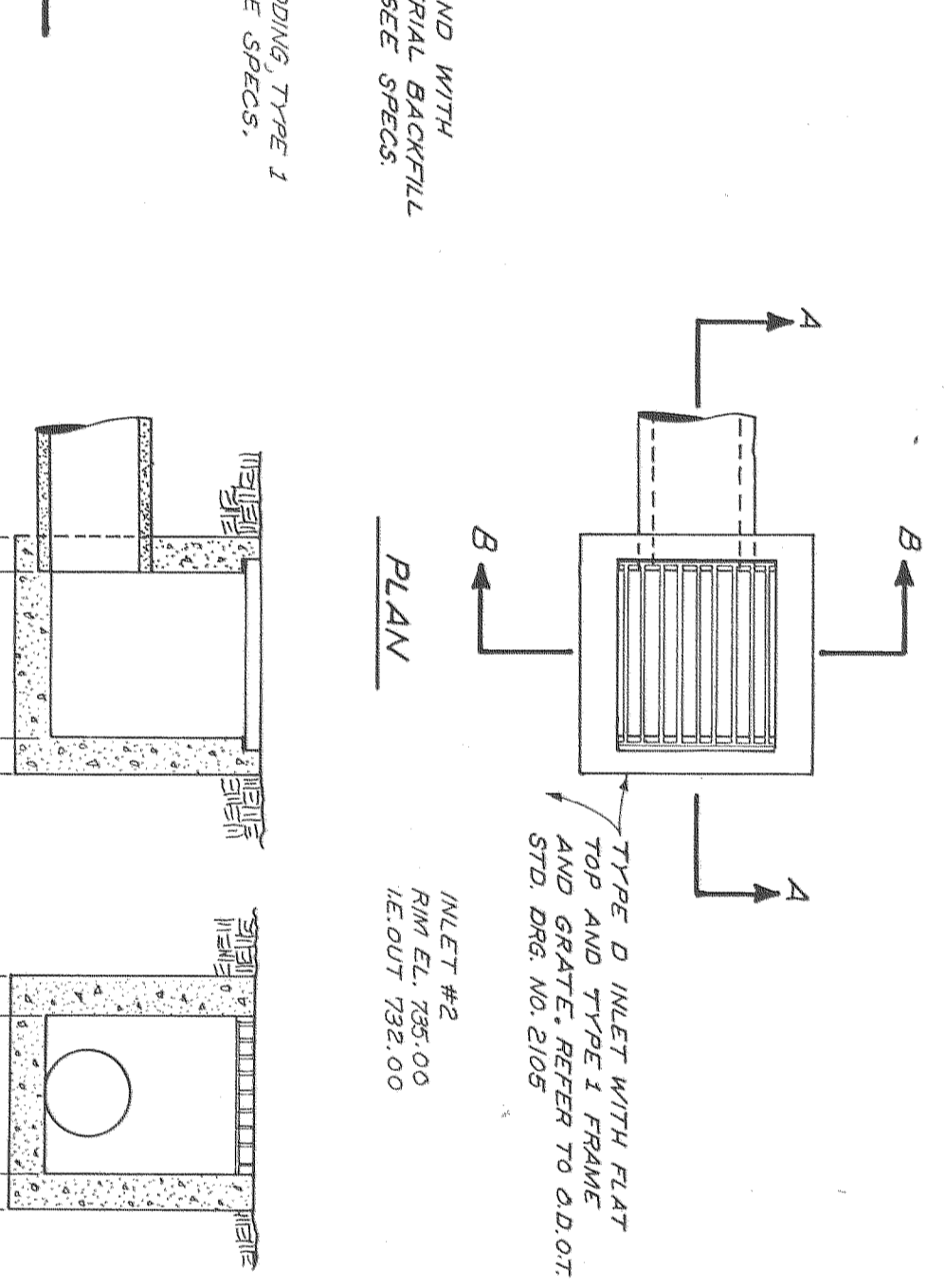
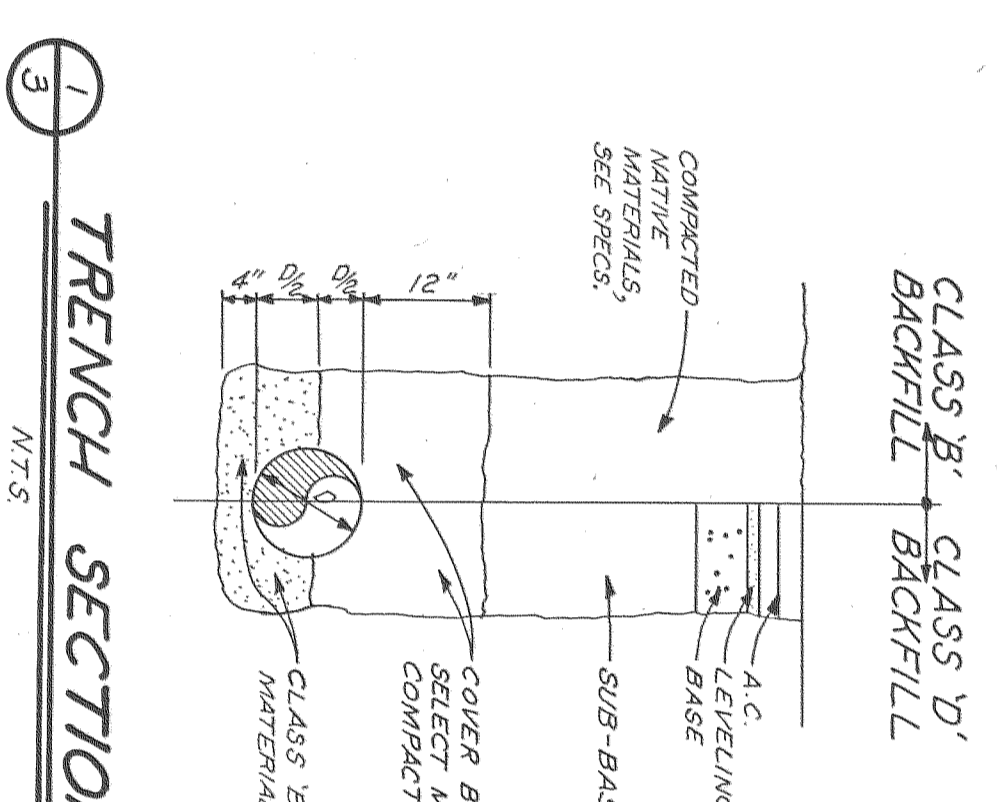
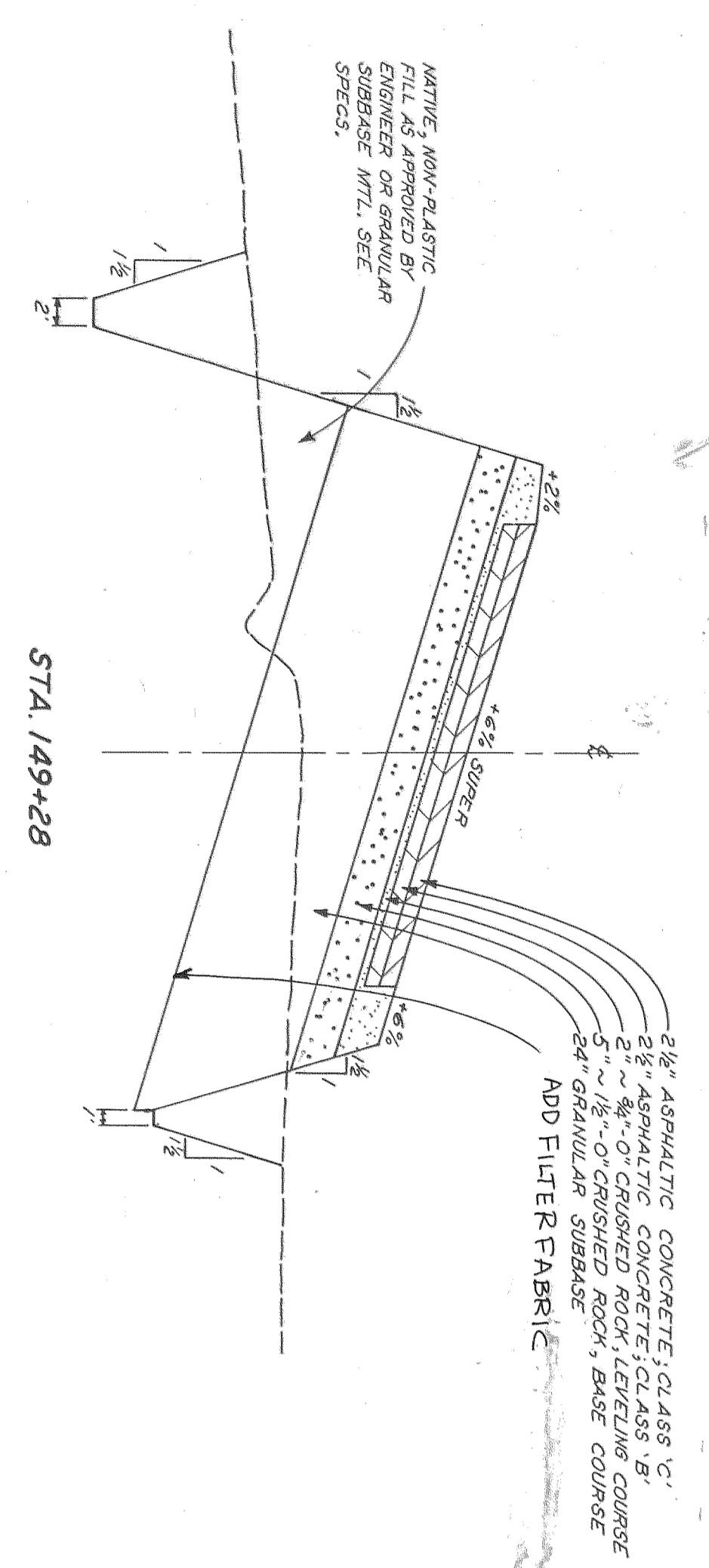

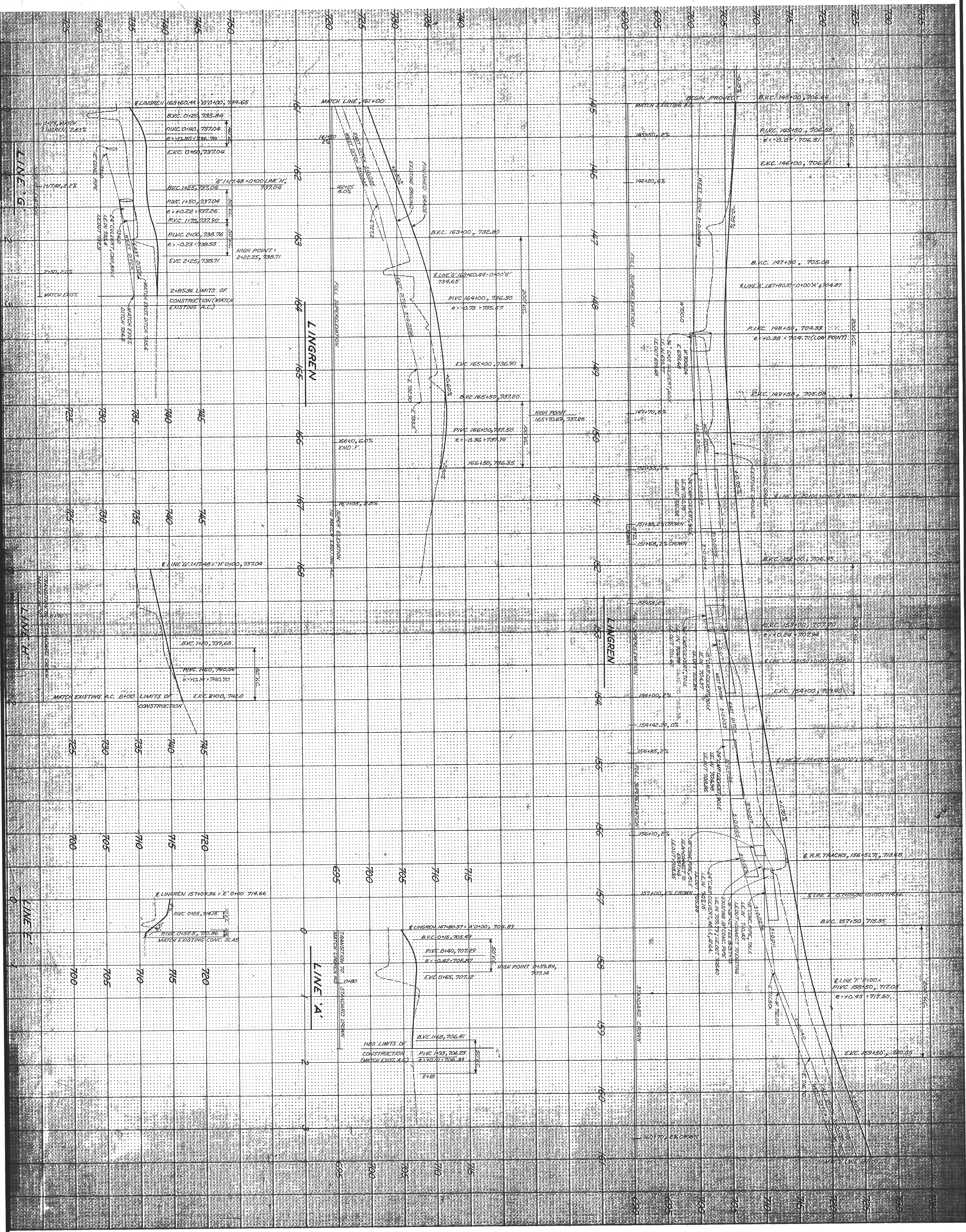

<p>2 of 3</p> <p>1451-00 7188</p>	<p>Robert E. Meyer Consultants Engineers • Architects • Planners • Surveyors 4805 S.W. Griffith Drive Beverton, Oregon 97005 (503) 643-7531</p>	<p>LINGREN ROAD IMPROVEMENTS HOOD RIVER COUNTY HOOD RIVER, OREGON</p>	<p>PROFILE</p> <p>SCALE HORIZ: 1"=50' VERT: 1"=5'</p>	<p>NO. BY DATE</p> <p>REVISIONS</p>
<p>DESIGN J.B. DRAWN J.B. CHECKED D.H.S. APPROVED</p>		<p>DATE DEC. 1992</p>		