

CASCADE LOCKS SECTION COLUMBIA RIVER HIGHWAY HOOD RIVER COUNTY					SHEET No. 2
FED. ROAD Div. No.	STATE	PROJECT NUMBER	FISCAL YEAR	TOTAL SHEETS	
8	OREGON			See Index	

PRELIMINARY COPY
APR 22 1959
SUBJECT TO CHANGE
ROAD DESIGN SECTION

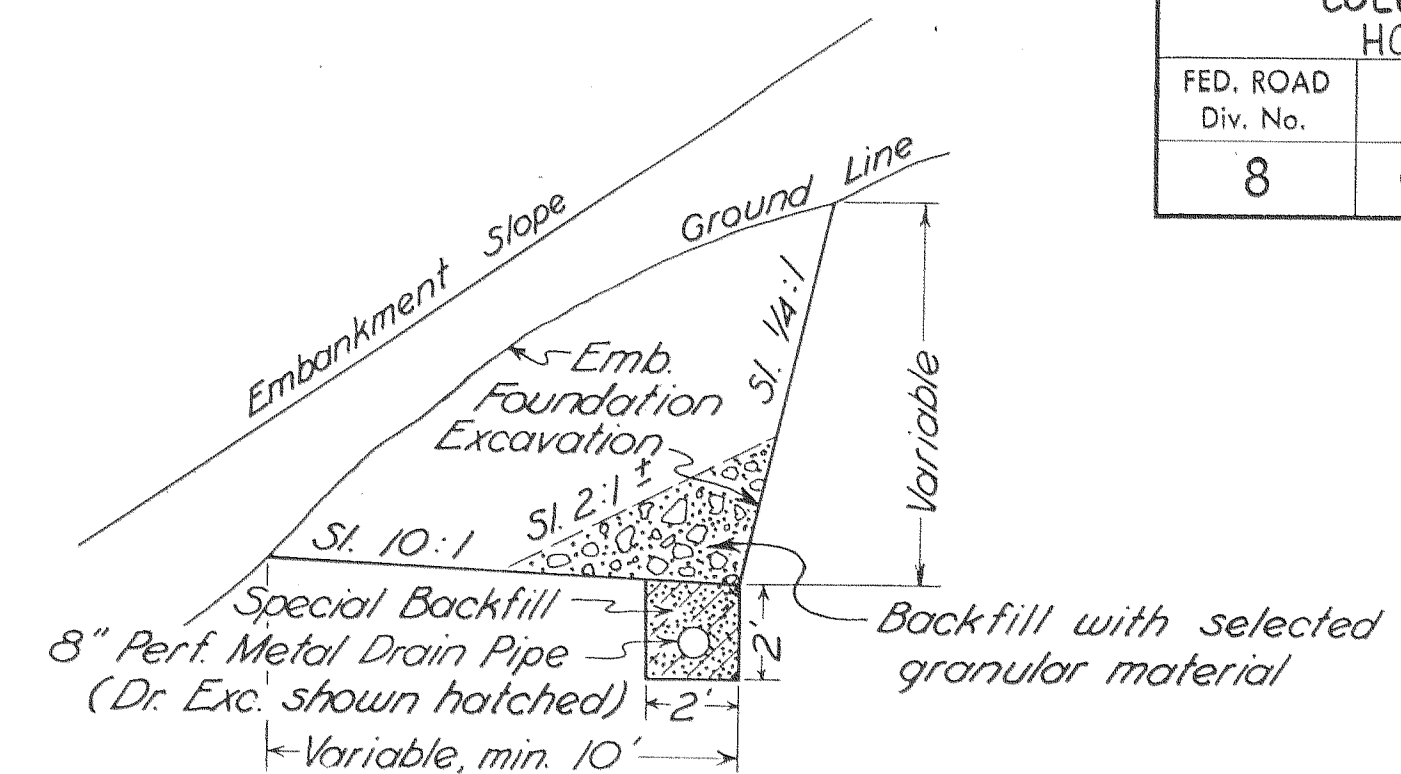

SLOPE BENCH SECTION

Sta. 1879+95 to 1880+65
1882+10 to 1883+40
1887+65 to 1888+55 (R.R. Access Road)

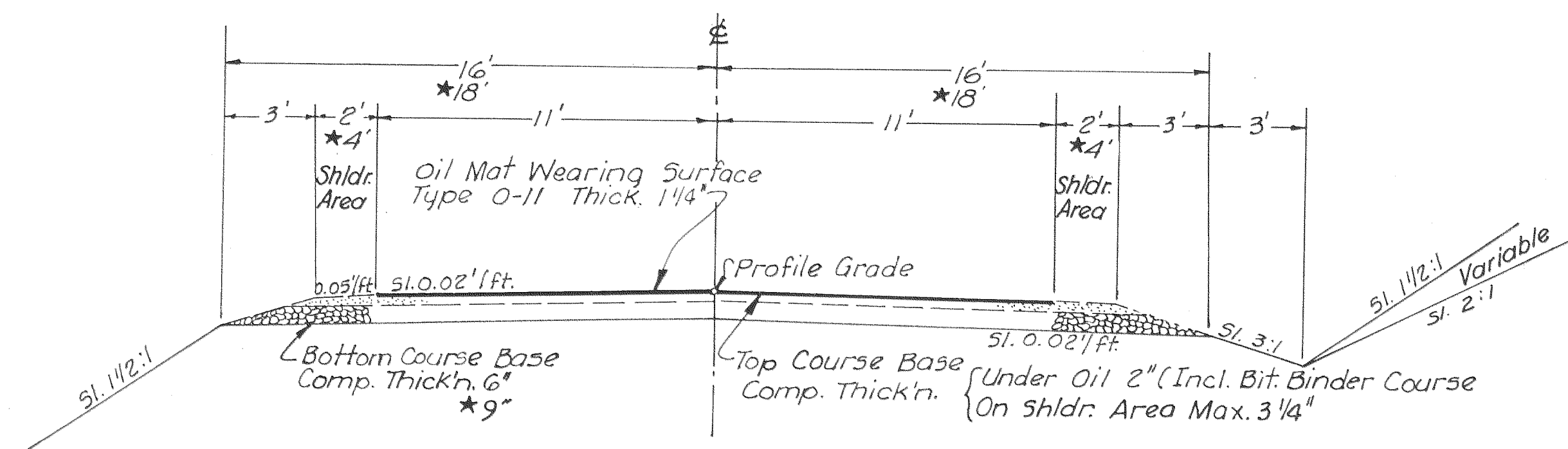

**MOODY AVE.
HAZEL ST.
'OX' LINE (GRADING ONLY)**

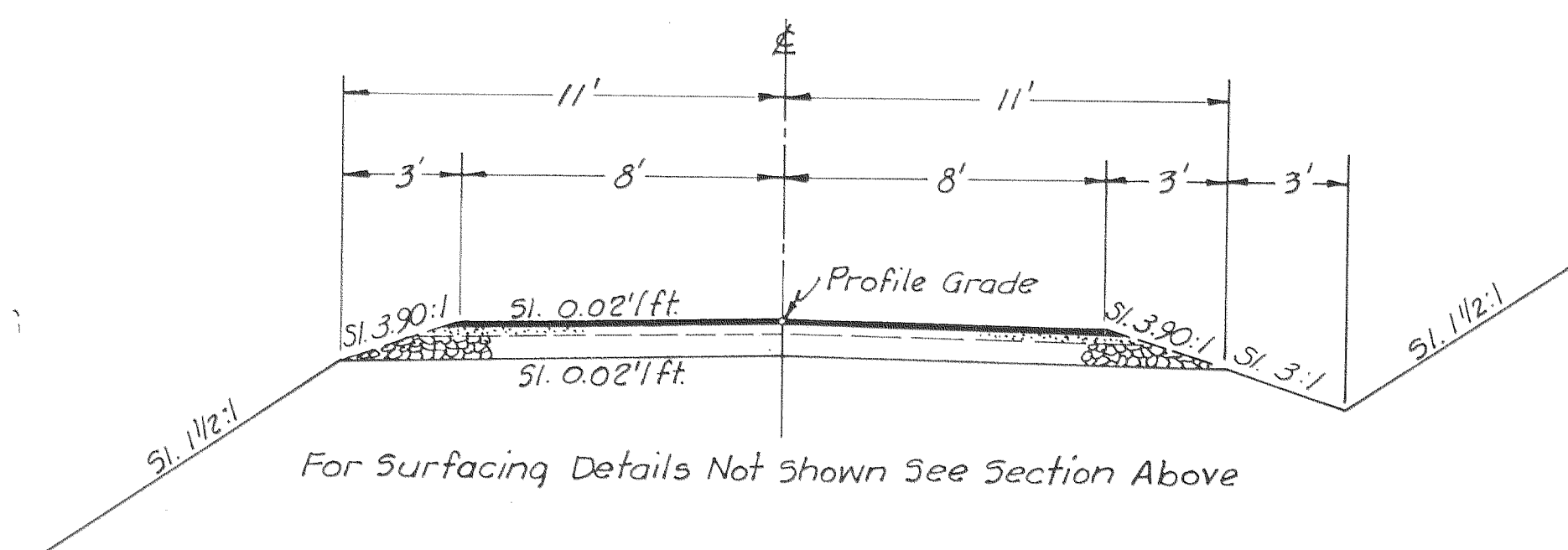

WATERSHED ROAD

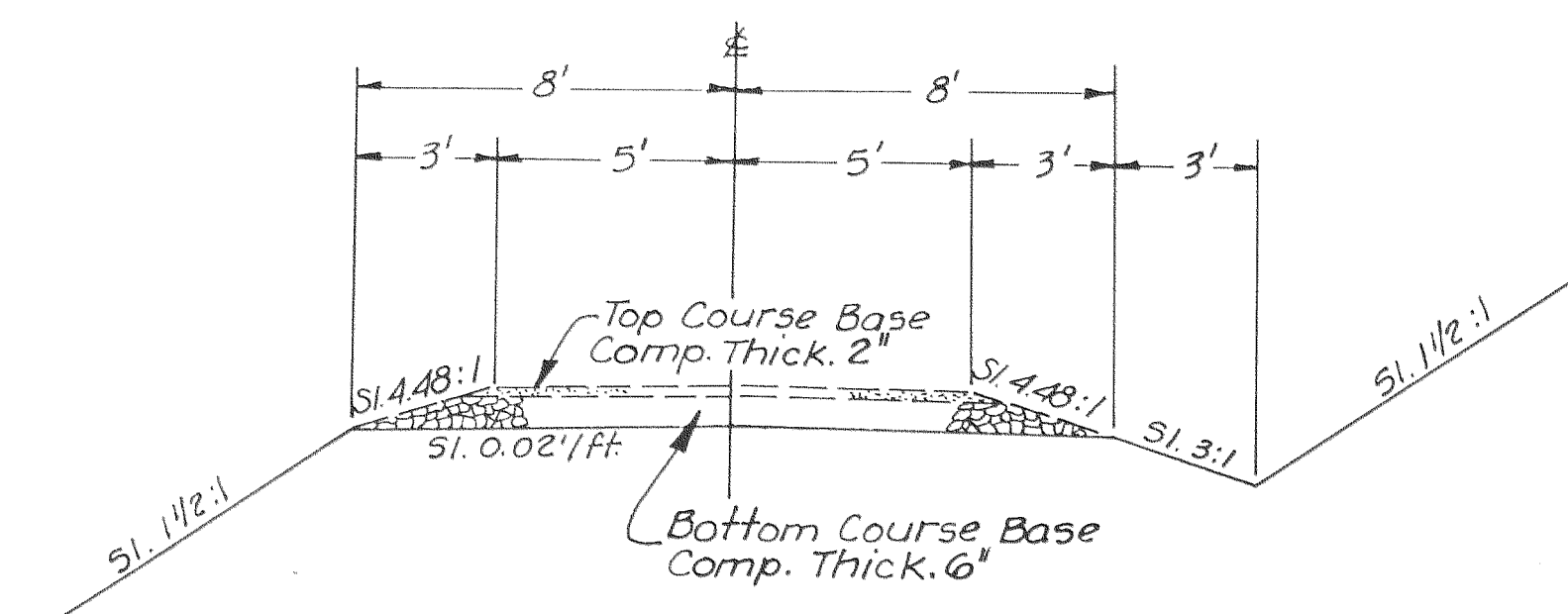

R.R. ACCESS ROAD

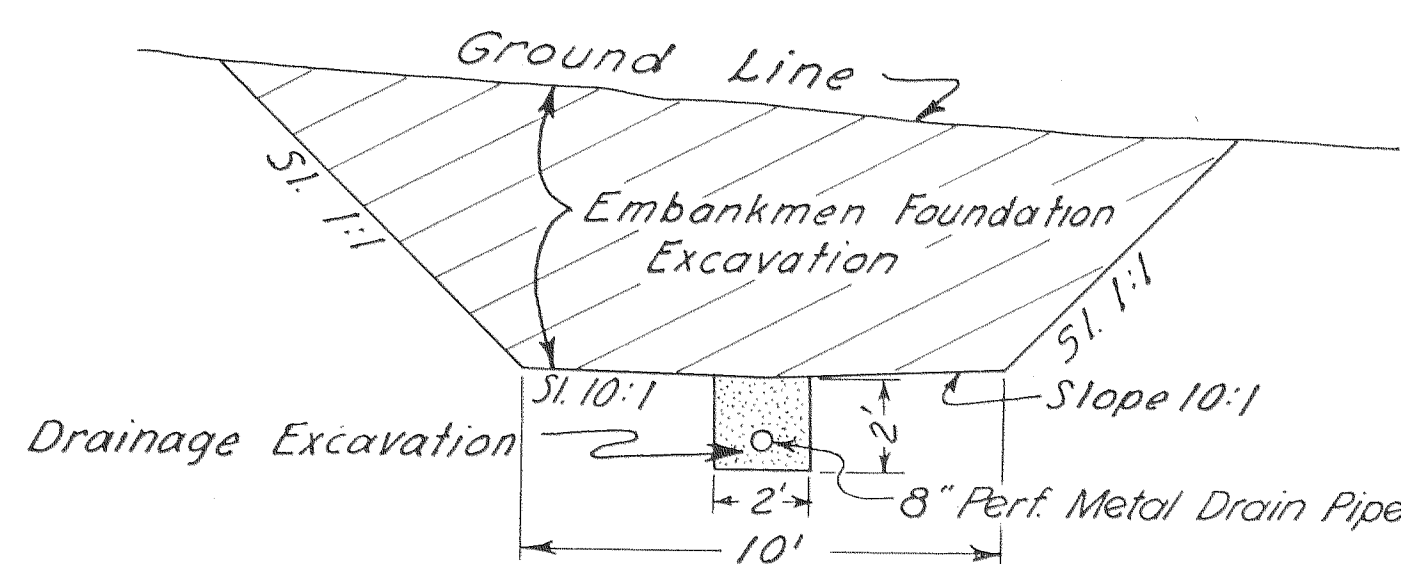

EMBANKMENT FOUNDATION DETAIL
STA. 1916+40 TO STA. 1918+00

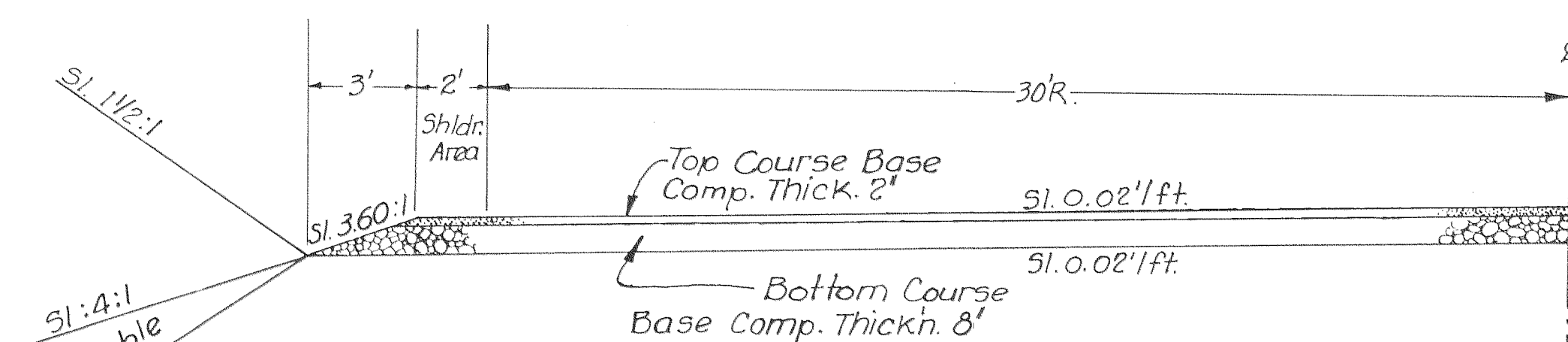

**EDGEWOOD DRIVE (Cul-de-Sac)
CITY STREET (Sta. 1905+65 Rt.) Cul-de-Sac**

CASCADE LOCKS SECTION COLUMBIA RIVER HIGHWAY HOOD RIVER COUNTY				SHEET No. 3
FED. ROAD Div. No.	STATE	PROJECT NUMBER	FISCAL YEAR	TOTAL SHEETS
8	OREGON			See Index

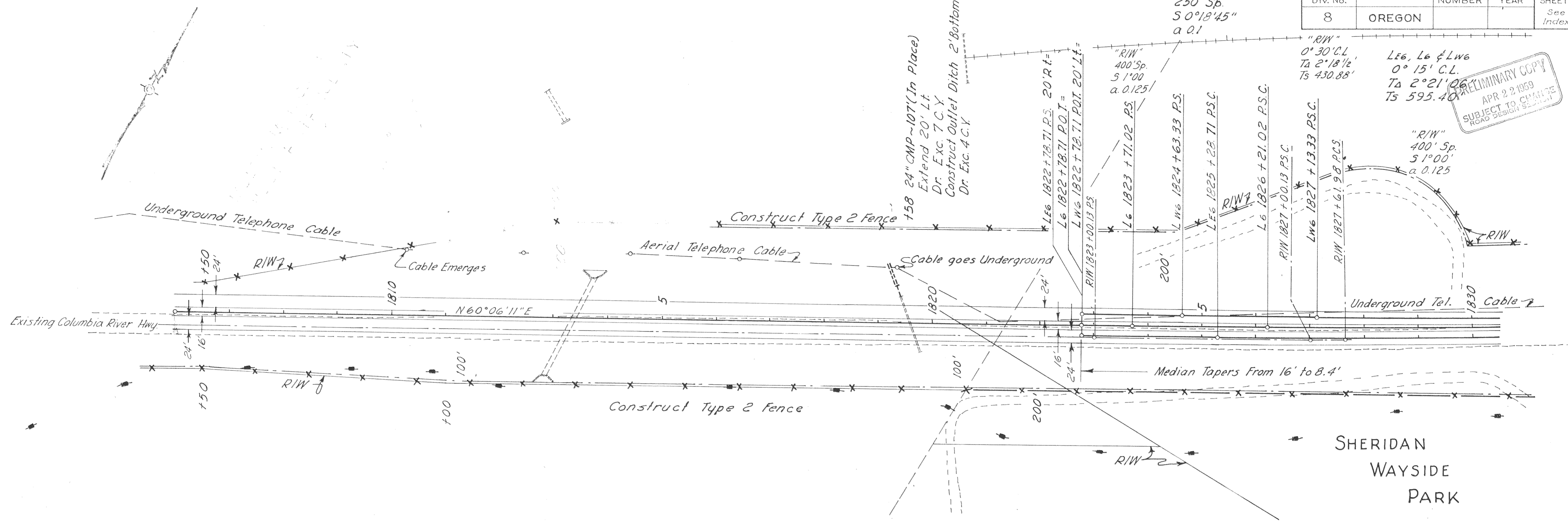

PRELIMINARY COPY
APR 22 1959
SUBJECT TO COMPLETE ROAD DESIGN SECTION

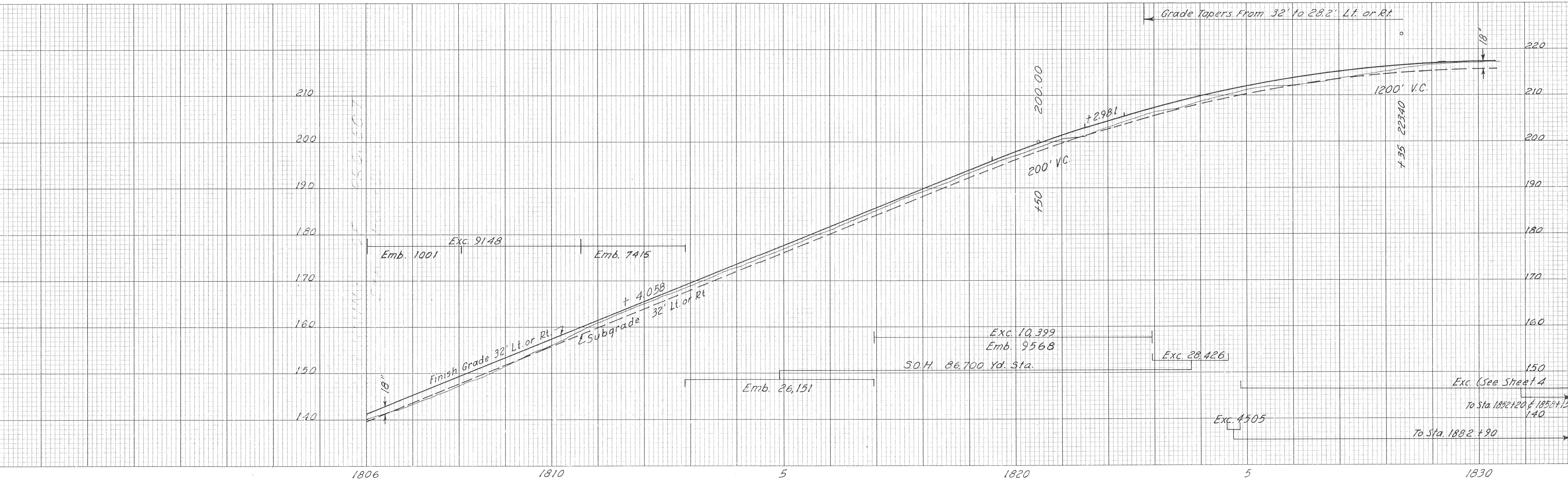

CASCADE LOCKS SECTION COLUMBIA RIVER HIGHWAY HOOD RIVER COUNTY				
FED. ROAD Div. No.	STATE	PROJECT NUMBER	FISCAL YEAR	TOTAL SHEETS
8	OREGON			See Index

SHEET
No. **4**
TOTAL
SHEETS
See
Index

PRELIMINARY COPY
APR 2 1959
SUBJECT TO CHANGE
ROAD DEPARTMENT

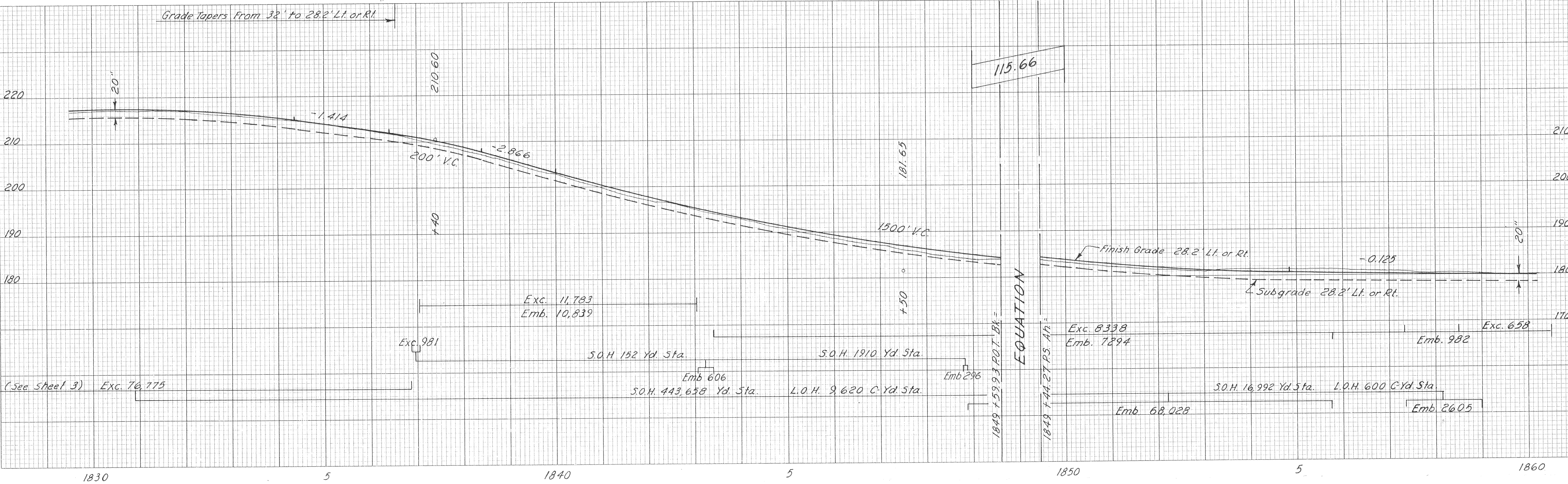
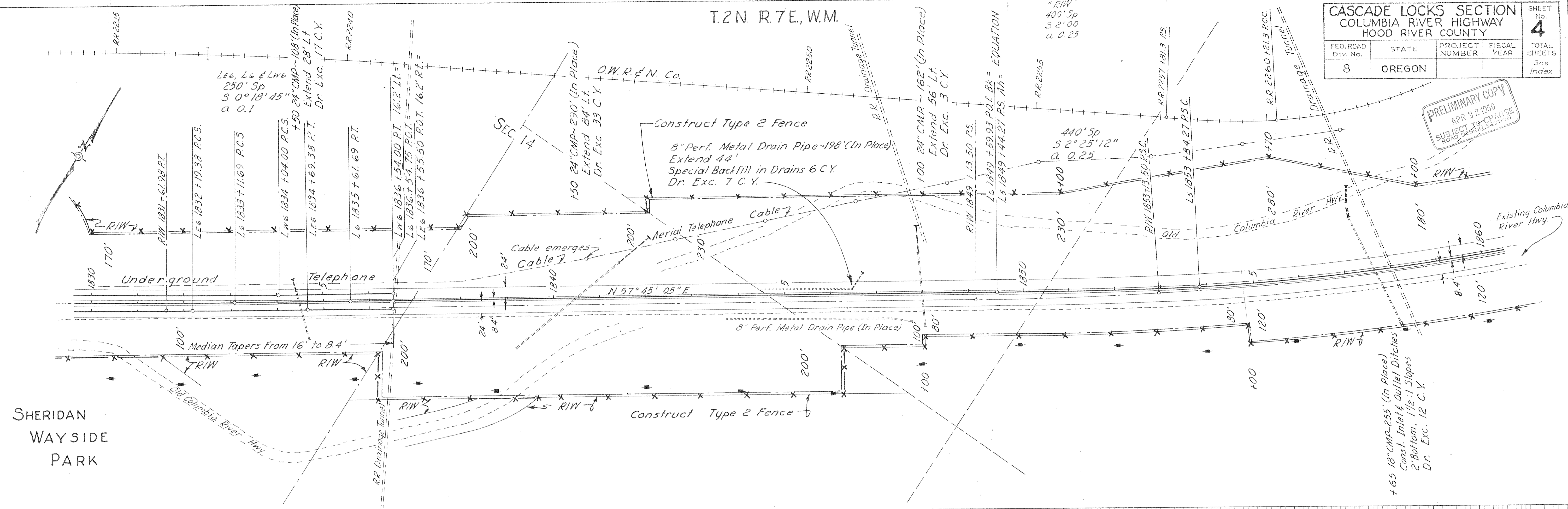

T2N, R7E, WM.

PRELIMINARY COPY
APR 2 9 1959
SUBJECT TO CHANGE
ROAD DESIGN SECTION

CASCADE LOCKS SECTION COLUMBIA RIVER HIGHWAY HOOD RIVER COUNTY				
FED. ROAD Div. No.	STATE	PROJECT NUMBER	FISCAL YEAR	SHEET No. 5
8	OREGON			TOTAL SHEETS See Index

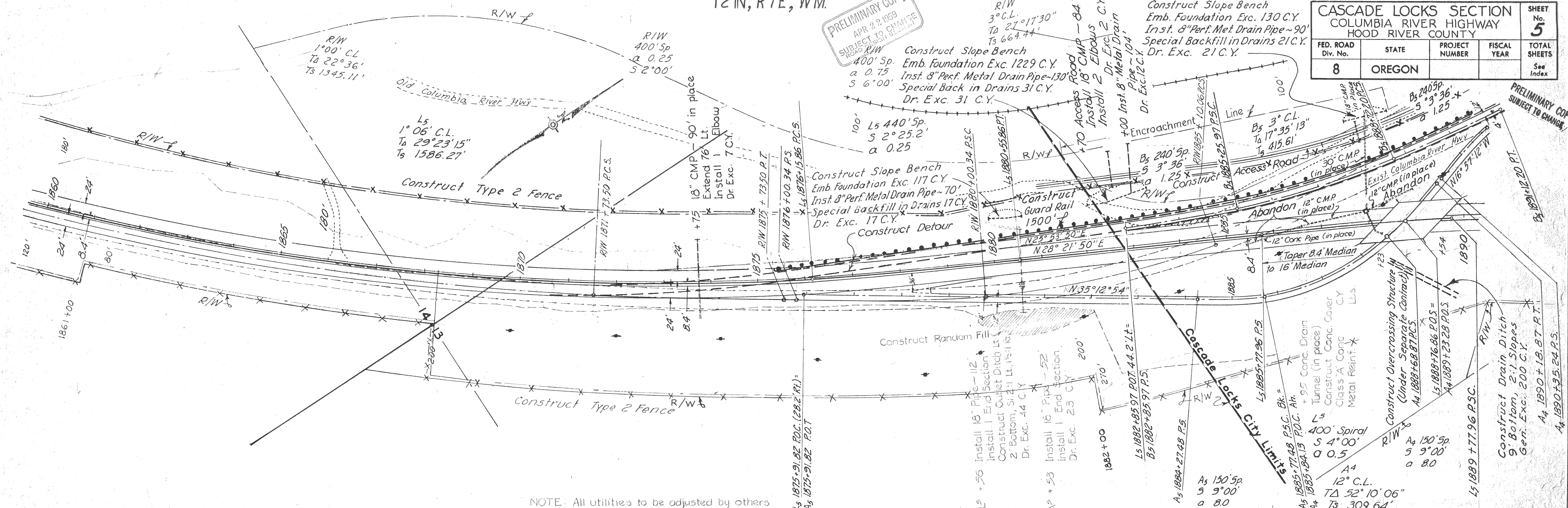

NOTE: All utilities to be adjusted by others

Grade Tapers From 28.2' to 32' Lt. or Rt.

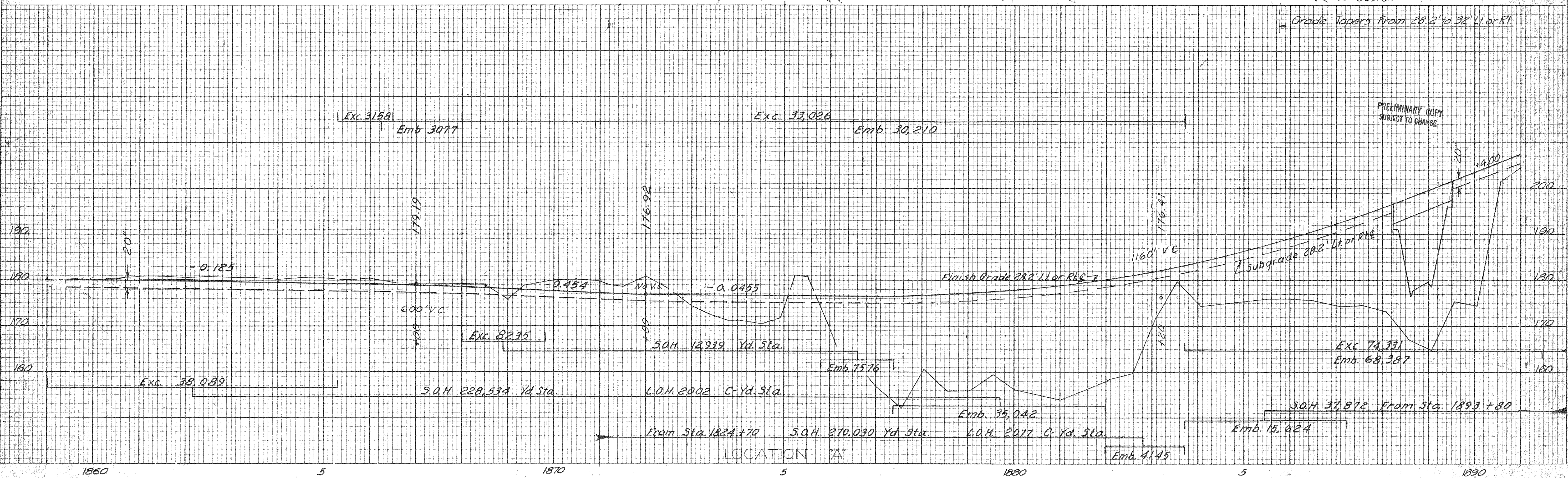

PRELIMINARY COPY
SUBJECT TO CHANGE

LOCATION 'A'

CASCADE LOCKS SECTION
COLUMBIA RIVER HIGHWAY
HOOD RIVER COUNTY

SHEET No. **5A**

FED. ROAD Div. No.	STATE	PROJECT NUMBER	FISCAL YEAR	TOTAL SHEETS
8	OREGON			See Index

PRELIMINARY COPY
APR 2 1959
SUBJECT TO CHANGE
ROAD DESIGN DEPT.

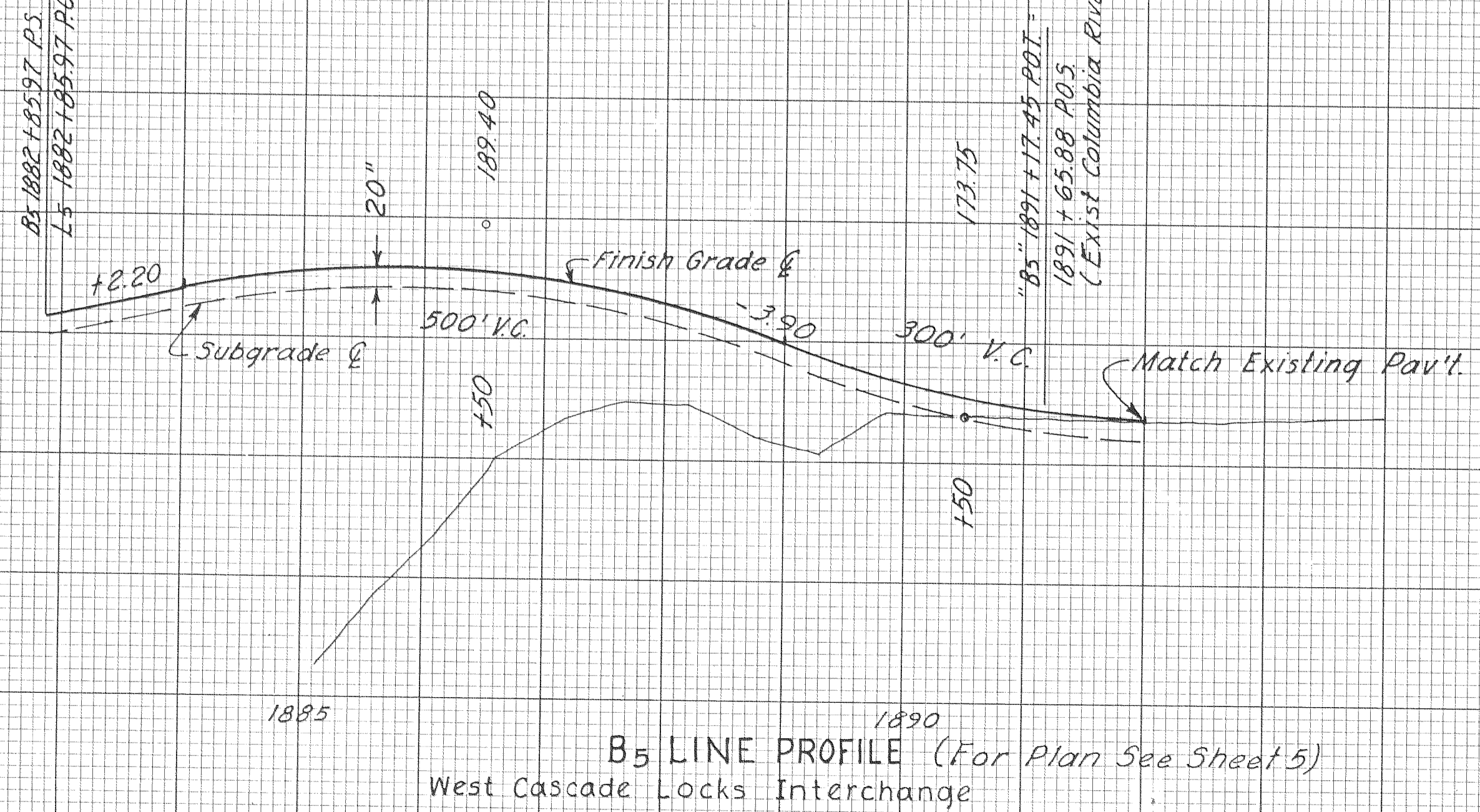
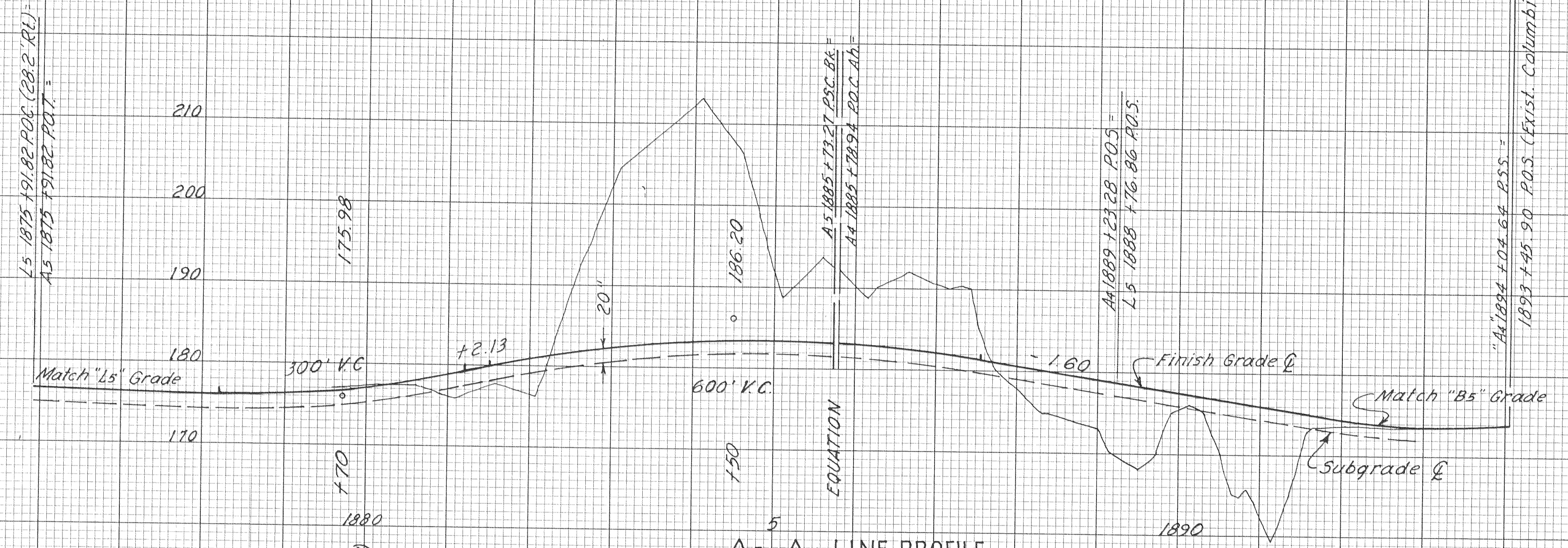
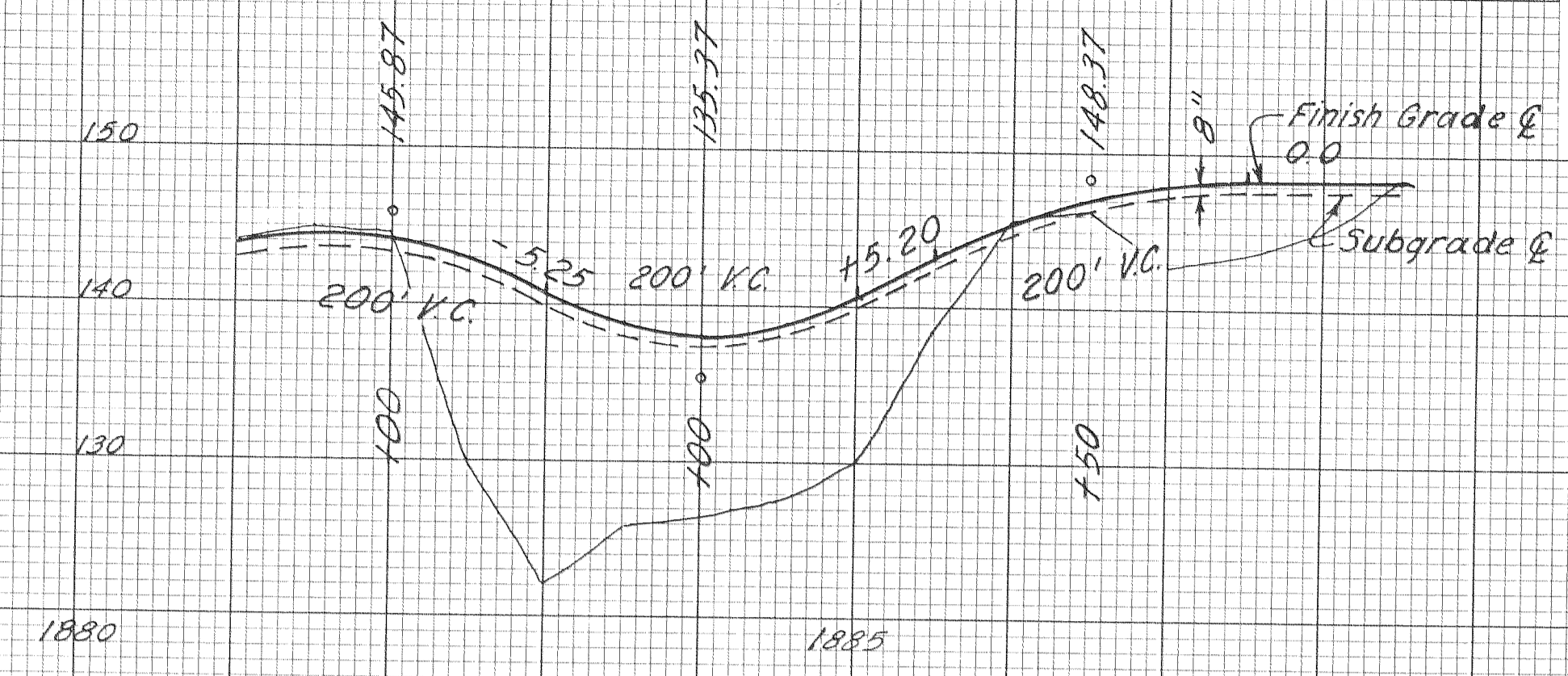

NO. AREAS CHECKED

CASCADE LOCKS SECTION				SHEET No.
COLUMBIA RIVER HIGHWAY				6
HOOD RIVER COUNTY				TOTAL SHEETS
FED. ROAD Div. No.	STATE	PROJECT NUMBER	FISCAL YEAR	See Index
8	OREGON			

PRELIMINARY COPY
 APR 22 1959
 SUBJECT TO CHANGE
 ROAD DESIGN 2541519

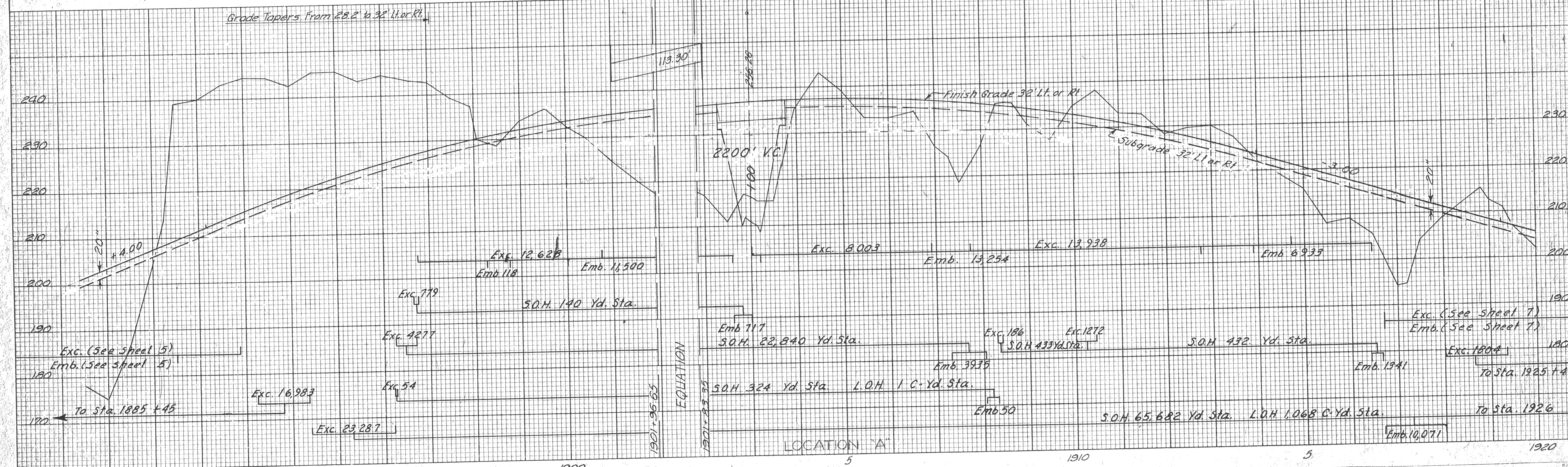
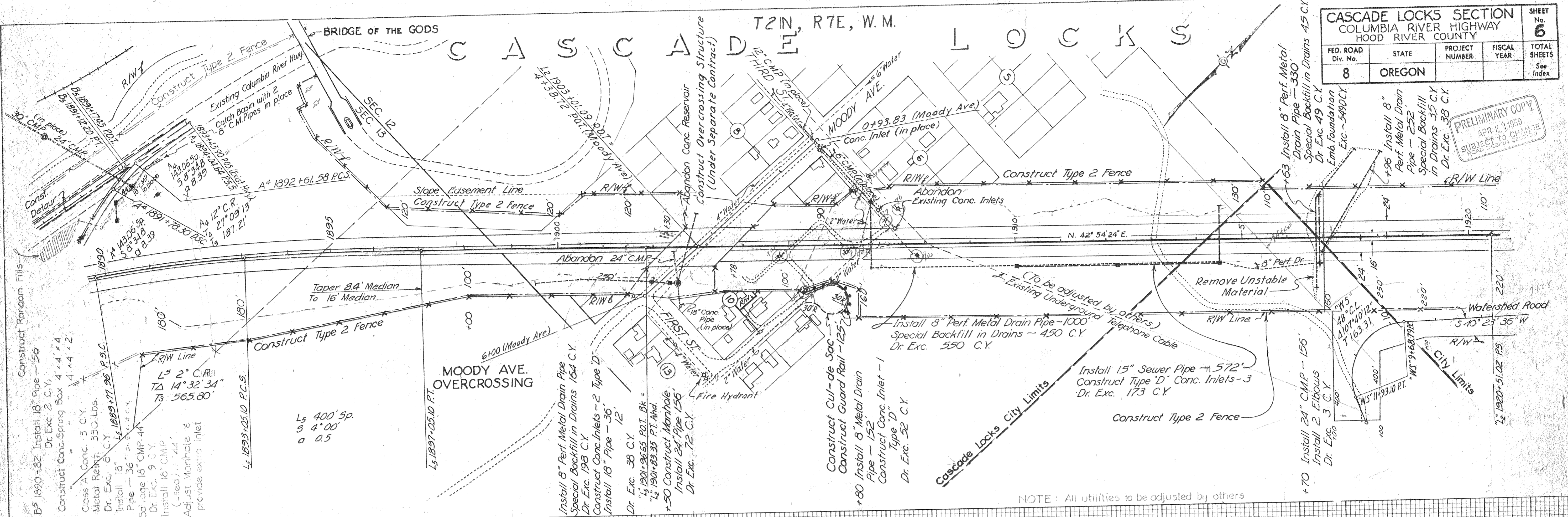

C A S C A D E L O C K S S E C T I O N

CASCADE LOCKS SECTION				SHEET No. 7
COLUMBIA RIVER HIGHWAY				TOTAL SHEETS
HOOD RIVER COUNTY				See Index
FED. ROAD Div. No.	STATE	PROJECT NUMBER	FISCAL YEAR	
8	OREGON			

PRELIMINARY COPY
 APR 22 1959
 SUBJECT TO CHANGE
 ROAD DESIGN SECTION

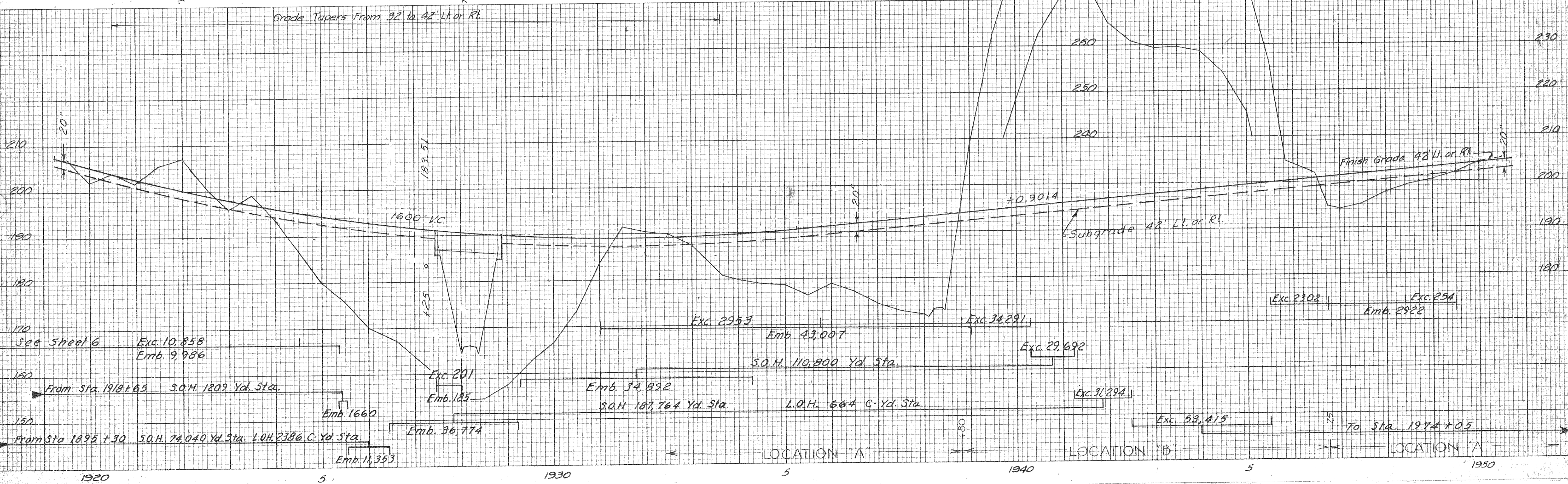
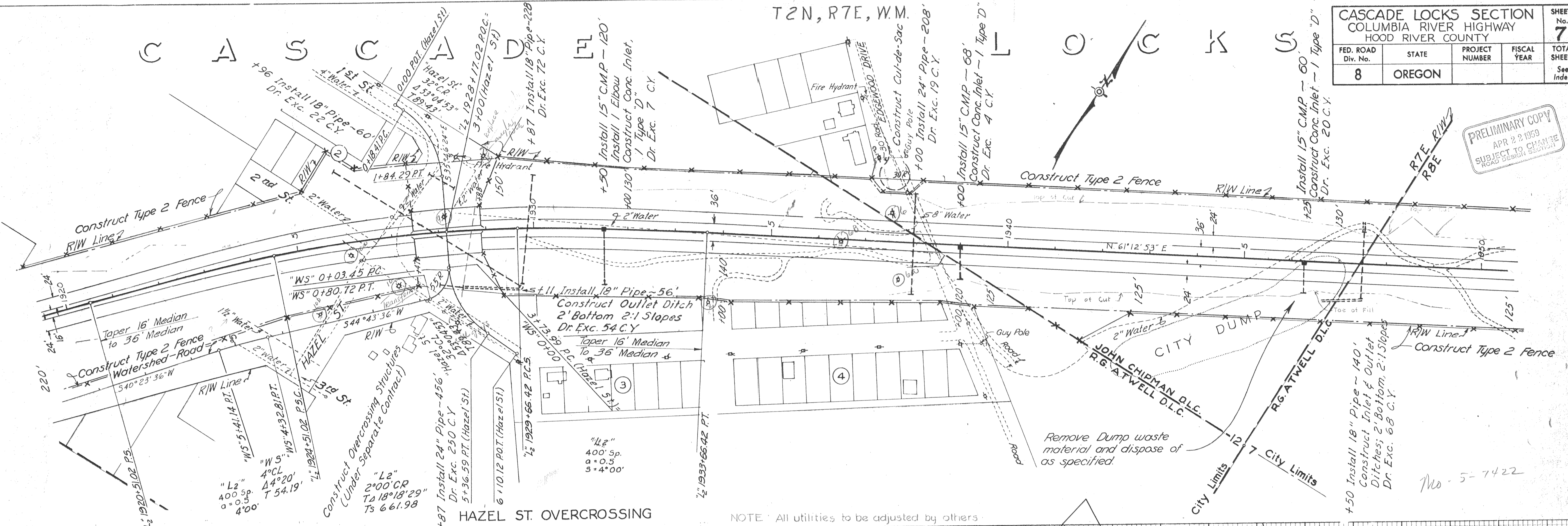

CASCADE LOCKS

CASCADE LOCKS SECTION					SHEET No.
COLUMBIA RIVER HIGHWAY					8
HOOD RIVER COUNTY					TOTAL SHEETS
FED. ROAD Div. No.	STATE	PROJECT NUMBER	FISCAL YEAR	See Index	
8	OREGON				

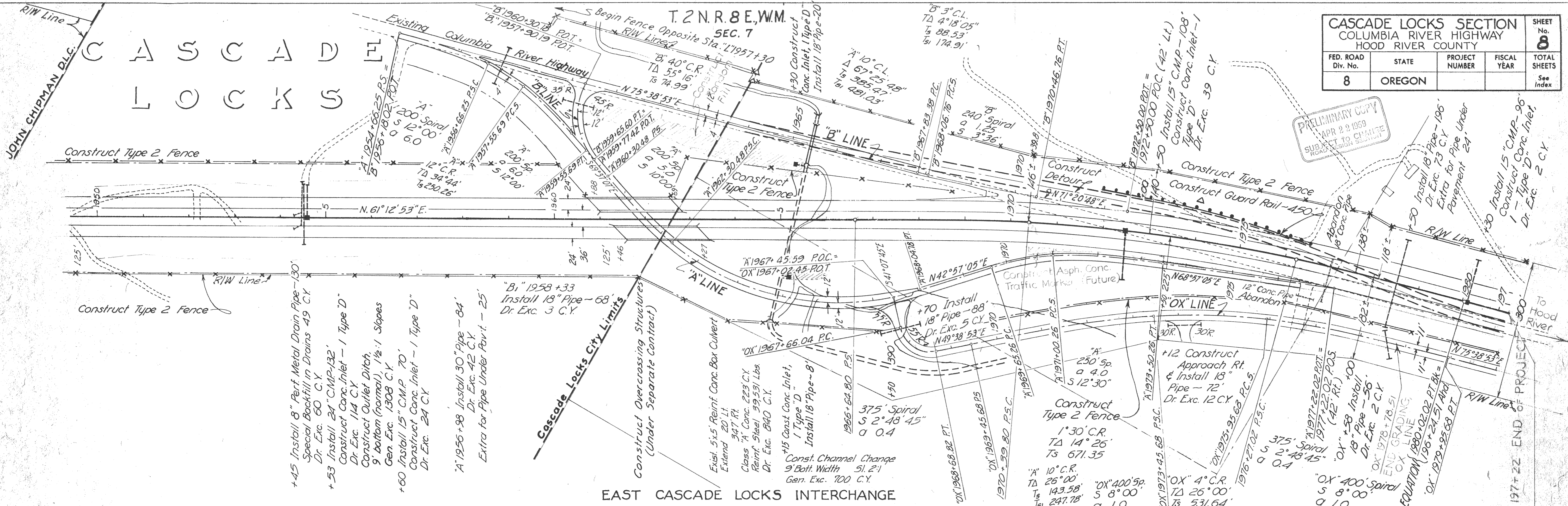

EAST CASCADE LOCKS INTERCHANGE

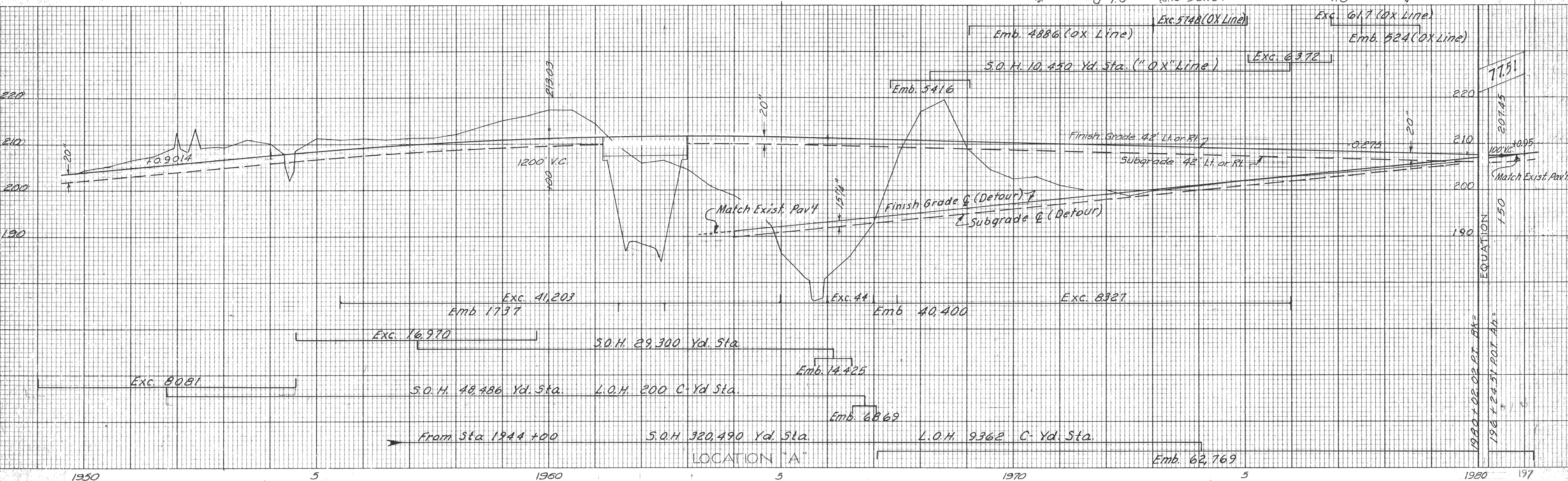

LOCATION "A"

PROFILES
(Earthwork included in Main Roadway Distribution)

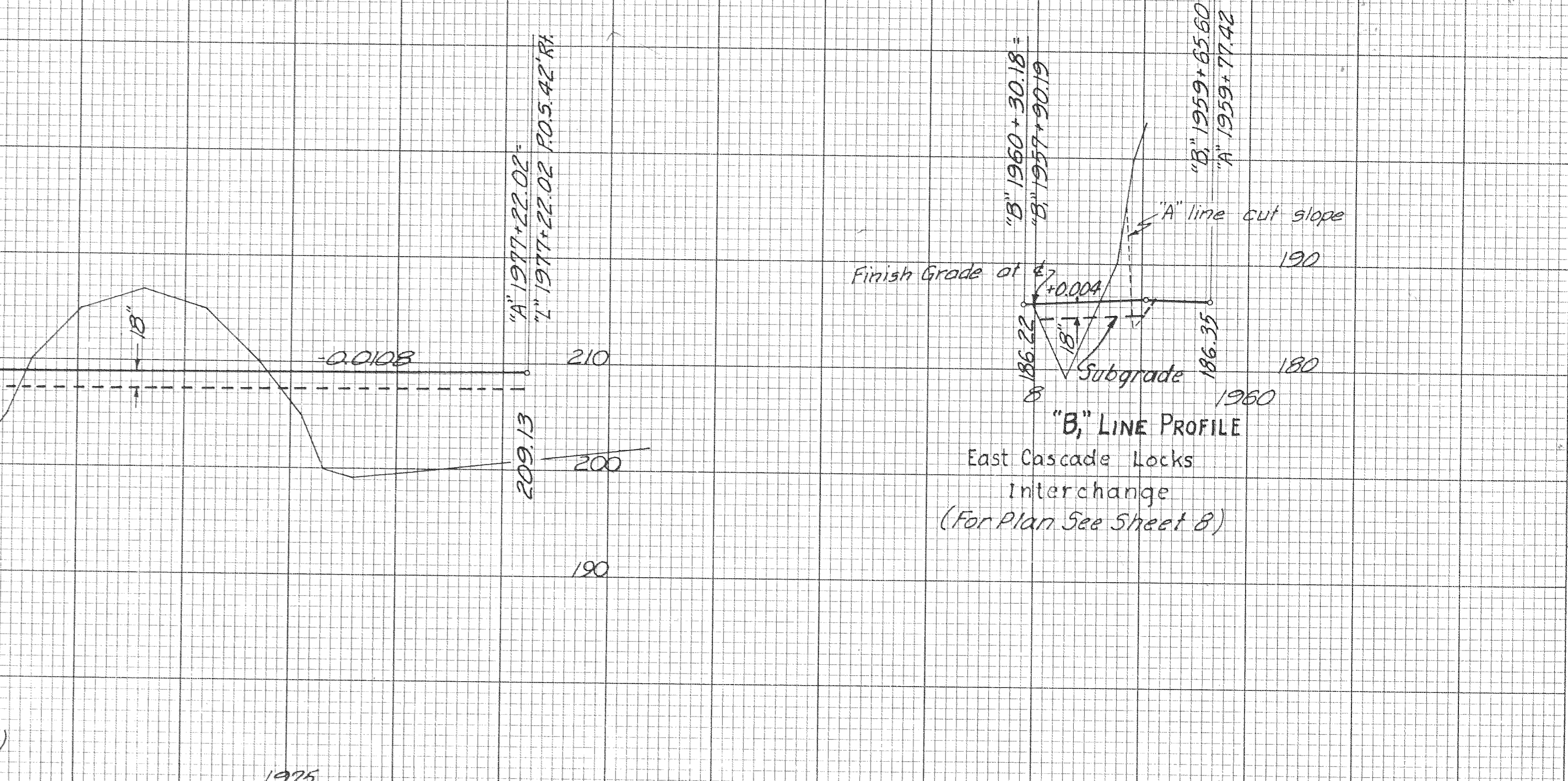
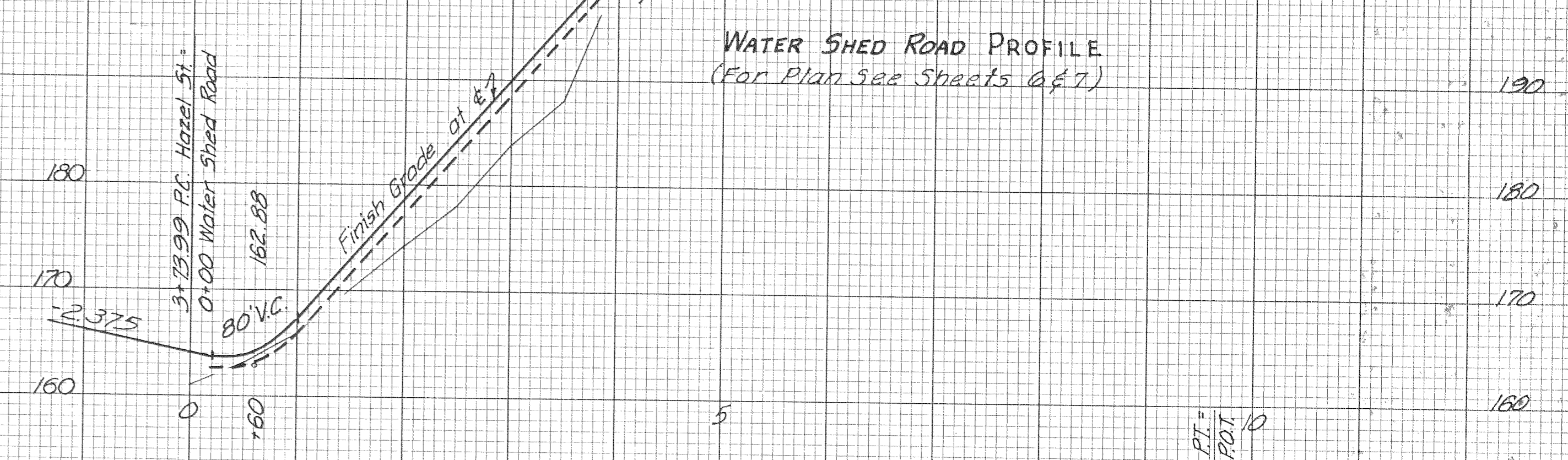
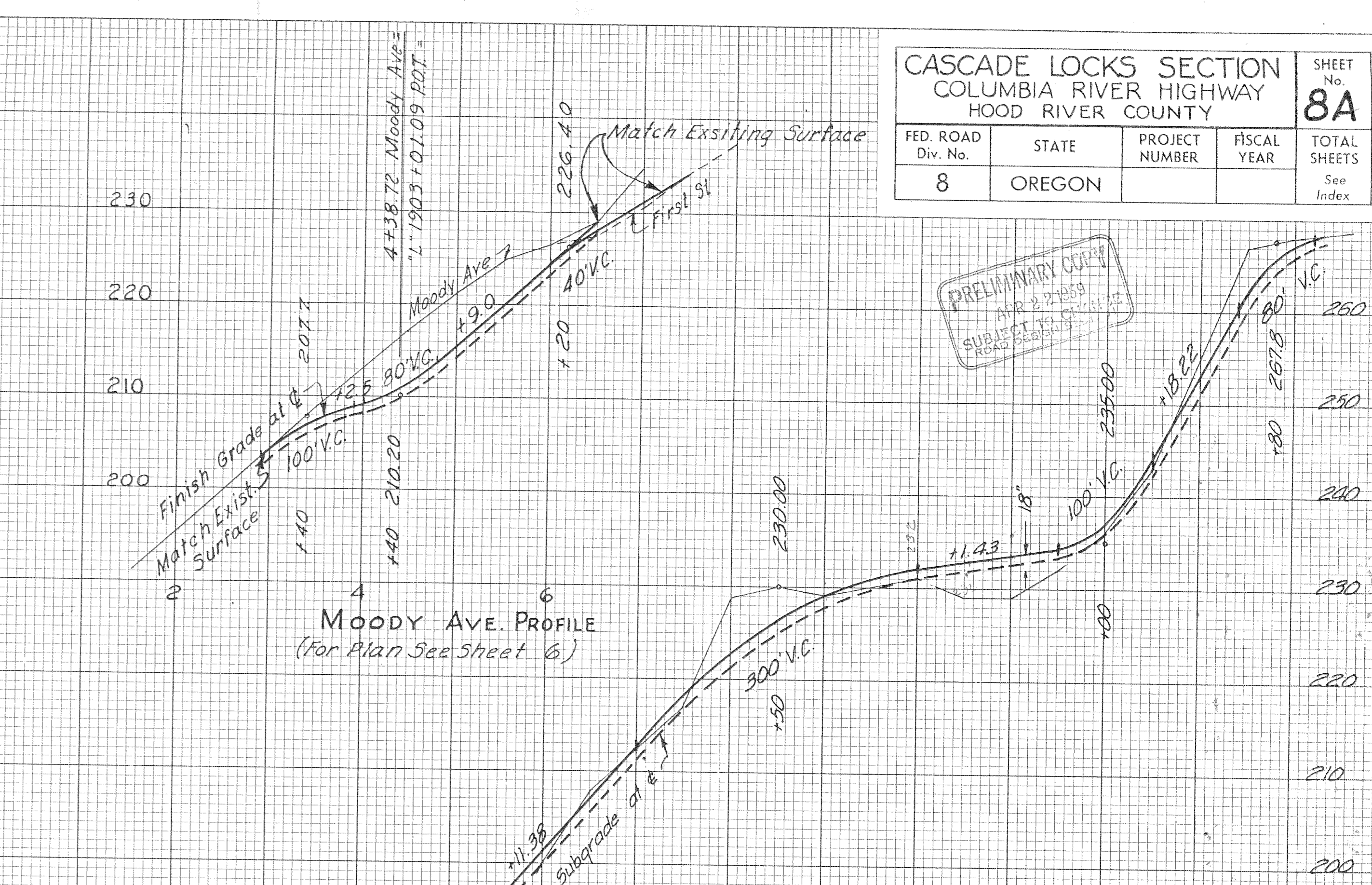
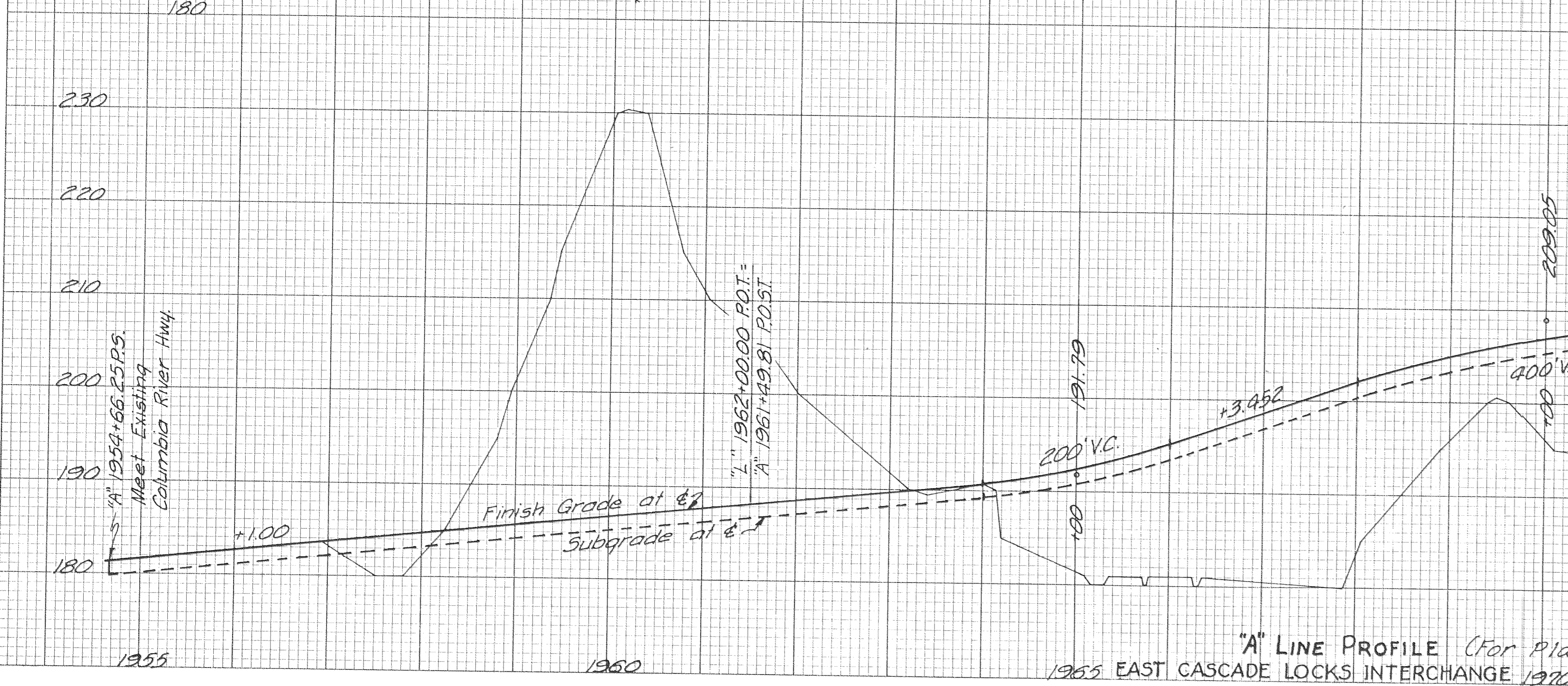
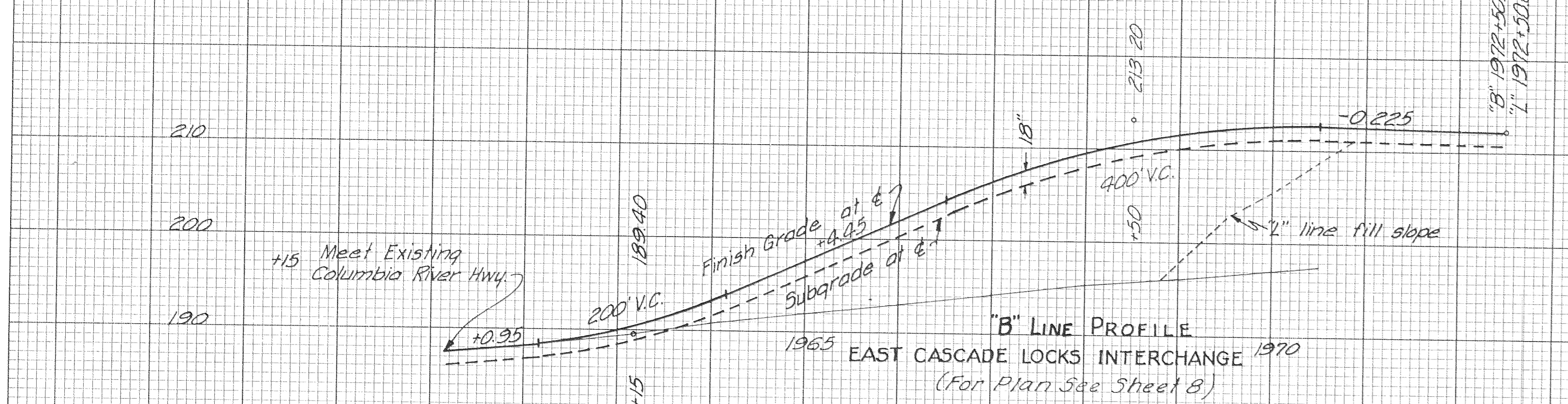
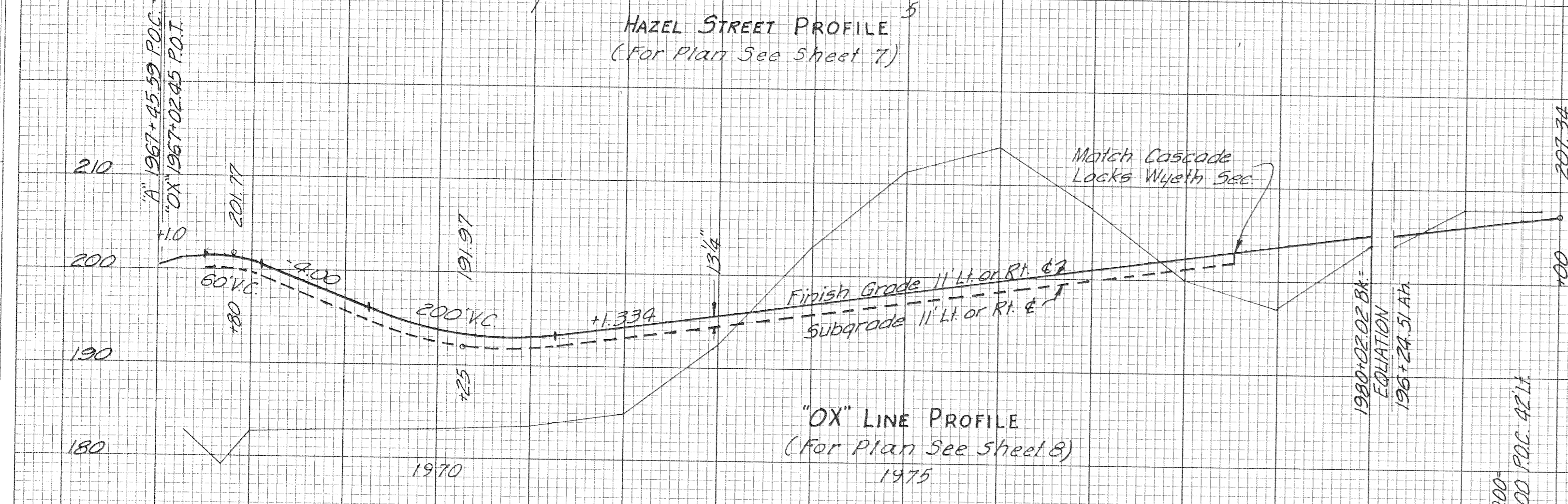
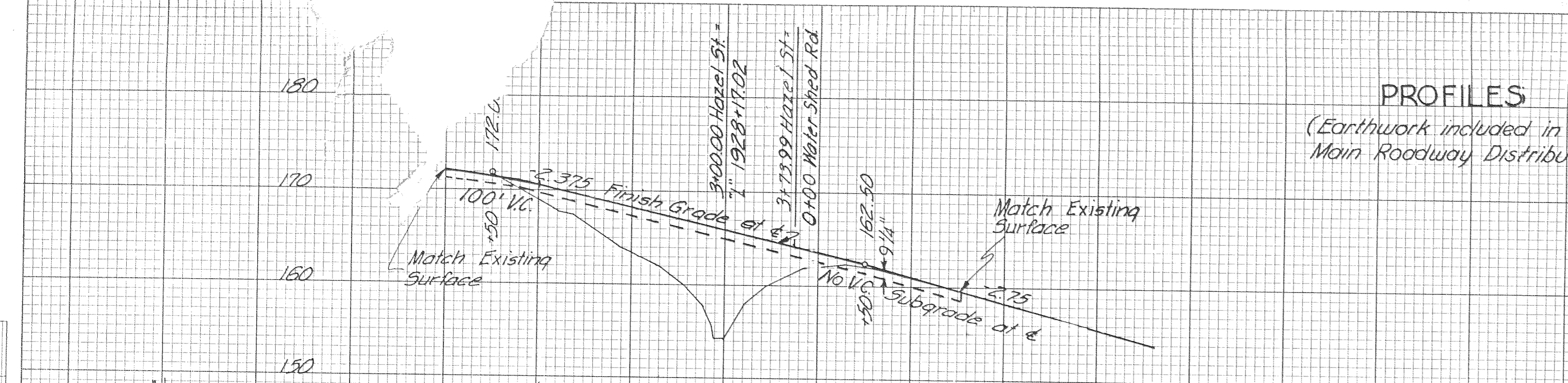

PRELIMINARY COPY
APR 22 1959
SUBJECT TO CHANGE
ROAD DESIGN